



CNC 8070



(REF: 1007)

HARDWARE CONFIGURATION

(Ref: 1007)

MACHINE SAFETY

It is up to the machine manufacturer to make sure that the safety of the machine is enabled in order to prevent personal injury and damage to the CNC or to the products connected to it. On start-up and while validating CNC parameters, it checks the status of the following safety elements:

- Feedback alarm for analog axes.
- Software limits for analog and sercos linear axes.
- Following error monitoring for analog and sercos axes (except the spindle) both at the CNC and at the drives.
- Tendency test on analog axes.

If any of them is disabled, the CNC shows a warning message and it must be enabled to guarantee a safe working environment.

FAGOR AUTOMATION shall not be held responsible for any personal injuries or physical damage caused or suffered by the CNC resulting from any of the safety elements being disabled.

HARDWARE EXPANSIONS

FAGOR AUTOMATION shall not be held responsible for any personal injuries or physical damage caused or suffered by the CNC resulting from any hardware manipulation by personnel unauthorized by Fagor Automation.

If the CNC hardware is modified by personnel unauthorized by Fagor Automation, it will no longer be under warranty.

COMPUTER VIRUSES

FAGOR AUTOMATION guarantees that the software installed contains no computer viruses. It is up to the user to keep the unit virus free in order to guarantee its proper operation.

Computer viruses at the CNC may cause it to malfunction. An antivirus software is highly recommended if the CNC is connected directly to another PC, it is part of a computer network or floppy disks or other computer media is used to transmit data.

FAGOR AUTOMATION shall not be held responsible for any personal injuries or physical damage caused or suffered by the CNC due a computer virus in the system.

If a computer virus is found in the system, the unit will no longer be under warranty.



All rights reserved. No part of this documentation may be transmitted, transcribed, stored in a backup device or translated into another language without Fagor Automation's consent. Unauthorized copying or distributing of this software is prohibited.

The information described in this manual may be changed due to technical modifications. Fagor Automation reserves the right to make any changes to the contents of this manual without prior notice.

All the trade marks appearing in the manual belong to the corresponding owners. The use of these marks by third parties for their own purpose could violate the rights of the owners.

It is possible that CNC can execute more functions than those described in its associated documentation; however, Fagor Automation does not guarantee the validity of those applications. Therefore, except under the express permission from Fagor Automation, any CNC application that is not described in the documentation must be considered as "impossible". In any case, Fagor Automation shall not be held responsible for any personal injuries or physical damage caused or suffered by the CNC if it is used in any way other than as explained in the related documentation.

The content of this manual and its validity for the product described here has been verified. Even so, involuntary errors are possible, thus no absolute match is guaranteed. Anyway, the contents of the manual is periodically checked making and including the necessary corrections in a future edition. We appreciate your suggestions for improvement.

The examples described in this manual are for learning purposes. Before using them in industrial applications, they must be properly adapted making sure that the safety regulations are fully met.

INDEX

About the product	7
Declaration of conformity	9
Version history	11
Safety conditions	13
Warranty terms	17
Material returning terms	19
CNC maintenance	21
Related documentation	23
CHAPTER 1	PREVIOUS INFORMATION.
CHAPTER 2	HARDWARE STRUCTURE.
2.1	Possible configurations. 29
CHAPTER 3	HEAT DISSIPATION. CENTRAL UNIT (CPU) ENCLOSURE.
3.1	Heat dissipation models. 35
CHAPTER 4	CENTRAL UNITS ICU - MCU.
4.1	Technical characteristics. 39
4.2	MCU central unit dimensions. 41
4.3	MCU-PCI central unit dimensions. 42
4.4	ICU central unit dimensions. 43
4.4.1	Dimensions of the central unit without monitor. 43
4.4.2	Dimensions of the central unit with LCD-10 monitor. 44
4.4.3	Dimensions of the central unit with LCD-10K monitor. 45
4.4.4	Dimensions of the central unit with LCD-15 monitor. 46
4.5	Dimensions and characteristics of the enclosure. 47
4.6	Elements (connectors). 50
4.6.1	Peripheral board. 50
4.6.2	Expansion board. 53
4.6.3	CPU board. 56
4.6.4	PCI expansion board (only for the MCU model). 58
4.6.5	Operator panel (only LCD-10K) 60
4.6.6	Digital inputs and outputs. Electrical characteristics. 61
4.6.7	Feedback inputs. Technical characteristics and connection. 62
4.7	Power connection. 64
4.8	housing for the compact flash and battery-powered RAM memory. 65
4.9	Insert the board into the PCI expansion (only in MCU models). 66
4.10	RS232 serial line connection. 68
4.11	RS422 serial line connection. 70
4.12	RS485 serial line connection. 72
4.13	Probe connection. 74
4.14	Connection to an Ethernet network. 76
CHAPTER 5	LCD-15SVGA. PASSIVE MONITOR " LCD15-SVGA ".
5.1	Possible configurations. 78
5.2	Technical characteristics. 79
5.3	Hardware dimensions. 80
5.4	Dimensions and characteristics of the enclosure. 81
5.5	Elements (connectors). 82
5.6	Overall connection. 83
CHAPTER 6	OP-PANEL-H/E MODULE. KEYBOARD AND OPERATOR PANEL.
6.1	Hardware dimensions. 85
6.2	Dimensions and characteristics of the enclosure. 86
6.3	Elements (connectors). 87

CHAPTER 7	KB-PANEL-H MODULE. INDEPENDENT KEYBOARD.	
	7.1 Hardware dimensions.	91
	7.2 Dimensions and characteristics of the enclosure.	92
	7.3 Elements (connectors).	93
CHAPTER 8	JOG-PANEL MODULE. INDEPENDENT OPERATOR PANEL.	
	8.1 Hardware dimensions.	95
	8.2 Dimensions and characteristics of the enclosure.	96
	8.3 Elements (connectors).	97
CHAPTER 9	MOUSE MODULE.	
	9.1 Hardware dimensions.	101
CHAPTER 10	RIO70 REMOTE MODULES. (CANFAGOR PROTOCOL).	
	10.1 Dimensions and mounting of the modules.	104
	10.2 Consumption of the remote modules.	106
	10.3 Power Supply.	107
	10.3.1 Elements (connectors).	108
	10.4 Digital inputs and outputs.	110
	10.4.1 Elements (connectors).	111
	10.5 Analog inputs and outputs.	112
	10.5.1 Elements (connectors).	113
	10.6 Feedback inputs (counter).	114
	10.6.1 Elements (connectors).	115
	10.7 Electrical characteristics of the inputs and outputs.	116
	10.8 Feedback inputs. Technical characteristics and connection.	117
	10.9 Numbering of the digital inputs and outputs.	119
	10.10 Numbering of the analog inputs and outputs and of the feedback inputs.	121
	10.11 Probe connection.	122
CHAPTER 11	RIO5 REMOTE MODULES. (CANOPEN PROTOCOL).	
	11.1 Dimensions and mounting of the modules.	126
	11.2 Power supply.	127
	11.2.1 Elements (connectors).	129
	11.3 Digital inputs and digital outputs (single module).	133
	11.3.1 Elements (connectors).	134
	11.4 Digital inputs and digital outputs (double module).	135
	11.4.1 Elements (connectors).	136
	11.5 Electrical characteristics of the inputs and outputs.	137
	11.6 Numbering of the digital inputs and outputs.	139
	11.7 Numbering of the analog inputs and outputs and of the temperature sensor inputs.	141
CHAPTER 12	RIOW REMOTE MODULES. (CANOPEN PROTOCOL).	
	12.1 Dimensions of the modules.	143
	12.2 Technical and electrical characteristics.	144
	12.2.1 Technical characteristics.	144
	12.2.2 Electrical characteristics of the inputs and outputs.	146
	12.3 Sizing of the remote groups.	148
	12.4 Installation of the modules.	150
	12.5 RIOW-CANOPEN-ECO module. Leading (first) module.	153
	12.5.1 Elements (connectors).	154
	12.5.2 Node configuration.	155
	12.5.3 Meaning of the LED's.	157
	12.6 RIOW-CANOPEN-STAND module. Leading (first) module.	160
	12.6.1 Elements (connectors).	161
	12.6.2 Voltage supply for the module.	163
	12.6.3 Node configuration.	164
	12.6.4 Meaning of the LED's.	166
	12.7 RIOW-PS24 module.	170
	12.7.1 Elements (connectors).	171
	12.8 RIOW-8DI module. Module of 8 digital inputs.	172
	12.8.1 Elements (connectors).	173
	12.9 RIOW-8DO module. Module of 8 digital outputs.	174
	12.9.1 Elements (connectors).	175
	12.10 RIOW-4AI module. Module of 4 analog inputs.	176
	12.10.1 Elements (connectors).	177
	12.11 RIOW-4AO module. Module of 4 analog outputs.	178
	12.11.1 Elements (connectors).	179



CNC 8070

(REF: 1007)

12.12	RIOW-2AI-PT100 module. Module of 2 inputs for PT100 temperature sensors.	180
12.12.1	Elements (connectors).	181
12.13	RIOW-END module. Last module of the group.	182
12.14	Numbering of the digital inputs and outputs.	183
12.15	Numbering of the analog inputs and outputs and of the temperature sensor inputs.	185
CHAPTER 13	EMERGENCY BATTERY.	
<hr/>		
13.1	Battery dimensions.	187
13.2	Connectors and connection.	188
13.3	Operation of the emergency battery.	189
CHAPTER 14	BUS CAN (CANFAGOR/CANOPEN PROTOCOLS).	
<hr/>		
14.1	Identification of the modules at the bus.	192
14.2	Type of CAN bus and baudrate.	194
14.3	Selecting the baudrate for the CANopen bus.	195
14.4	Selecting the speed for the CANfagor bus.	197
CHAPTER 15	SERCOS BUS.	
<hr/>		
15.1	Module identification and connection	200
15.2	Data exchange via Sercos.	201
CHAPTER 16	MECHATROLINK BUS.	
<hr/>		
CHAPTER 17	INSTALLING AND CONFIGURING A THIN CLIENT (EPATEC MODEL).	
<hr/>		
17.1	Install and configure the communication software at the CNC.	206
17.2	Configuring the Thin Client.	208
17.2.1	Configure the network protocol (for network or point-to point connection).	208
17.2.2	Configure the communication between the CNC and the Thin Client.	209
17.2.3	Configuring the startup of the Thin Client.	210
17.2.4	Disable the mouse at the Thin Client.	211



ABOUT THE PRODUCT

BASIC CHARACTERISTICS.

Basic characteristics.	.BL.	.OL.	.M. / .T.
PC-based system.	Closed system	Open system	
Operating system.	Windows XP		
Number of axes.	3 to 7	3 to 28	
Number of spindles.	1	1 to 4	
Number of tool magazines.	1	1 to 4	
Number of execution channels.	1	1 to 4	
Number of handwheels.	1 to 12		
Type of servo system.	Analog / Digital Sercos / Digital Mechatrolink		
Communications.	RS485 / RS422 / RS232 Ethernet		
PCI expansion.	No	Option	No
Integrated PLC.			
PLC execution time.	< 1ms/K		
Digital inputs / Digital outputs.	1024 / 1024		
Marks / Registers.	8192 / 1024		
Timers / Counters.	512 / 256		
Symbols.	Unlimited		
Block processing time.	< 1 ms		

Remote modules.	RIOW	RIO5	RIO70
Communication with the remote modules.	CANopen	CANopen	CANfagor
Digital inputs per module.	8	16 or 32	16
Digital outputs per module.	8	24 or 48	16
Analog inputs per module.	4	4	8
Analog outputs per module.	4	4	4
Inputs for PT100 temperature sensors.	2	2	---
Feedback inputs.	---	---	4 Differential TTL Sinusoidal 1 Vpp

Customizing.

PC-based open system, fully customizable.
 INI configuration files.
 FGUIM visual configuration tool.
 Visual Basic®, Visual C++®, etc.
 Internal databases in Microsoft® Access.
 OPC compatible interface



CNC 8070

(REF: 1007)

SOFTWARE OPTIONS.

Bear in mind that some of the features described in this manual depend on the software options that are installed. The information of the following table is informative only; when purchasing the software options, only the information provided in the ordering handbook is valid.

	-BL- model	-OL- model	-M- model	-T- model
Open system. Access to the administrator mode.	- - -	Option	Option	Option
Editing and simulation environment.	- - -	Option	Option	Option
Number of execution channels	1	1 to 4	1 to 4	1 to 4
Number of axes	3 to 7	3 to 28	3 to 28	3 to 28
Number of spindles	1	1 to 4	1 to 4	1 to 4
Number of tool magazines	1	1 to 4	1 to 4	1 to 4
Number of interpolated axes	2 to 4	2 to 28	2 to 28	2 to 28
COCOM version	Standard	Option	Option	Option
Dual-purpose machines (M-T)	- - -	Option	Option	Option
Non-Fagor digital drive	Option	Option	Option	Option
Tool radius compensation	Option	Option	Standard	Standard
"C" axis	Option	Option	Standard	Option
RTCP transformation	Option	- - -	Option	Option
High speed machining (HSC).	Option	Option	Option	Option
Probing canned cycles	- - -	- - -	Option	Option
Drilling ISO cycles for the OL model. (G80, G81, G82, G83).	- - -	Option	- - -	- - -
Tandem axes	- - -	Option	Option	Option
Synchronism and cams	Option	Option	Option	Option
Tangential control	Option	Option	Option	Option



CNC 8070

(REF: 1007)

DECLARATION OF CONFORMITY

The manufacturer:

Fagor Automation, S. Coop.
Barrio de San Andrés Nº 19, C.P. 20500, Mondragón -Guipúzcoa- (SPAIN).

Declares:

The manufacturer declares under their exclusive responsibility the conformity of the product:

8070 CNC

Consisting of the following modules and accessories:

8070-M-ICU, 8070-T-ICU, 8070-OL-ICU, 8070-BL-ICU
8070-M-MCU, 8070-T-MCU, 8070-OL-MCU, 8070-BL-MCU, 8070-OL-MCU-PCI
8070-LCD-10, 8070-LCD-15, LCD-15-SVGA
JOG PANEL, KEYBOARD PANEL, OP PANEL
BATTERY, MOUSE UNIT
Remote Modules RIOW, RIO5, RIO70

Note. Some additional characters may follow the model references indicated above. They all comply with the directives listed here. However, compliance may be verified on the label of the unit itself.

Referred to by this declaration with following directives.

Low-voltage regulations.

EN 60204-1: 2006 Electrical equipment on machines — Part1. General requirements

Regulation on electromagnetic compatibility.

EN 61131-2: 2007 PLC — Part2. Equipment requirements and tests

According to the European Community Directives 2006/95/EC on Low Voltage and 2004/108/EC on Electromagnetic Compatibility and their updates.

In Mondragón, July 27th 2010.

Fagor Automation, S. Coop.

Director Gerente
Pedro Ruiz de Aguirre



CNC 8070

(REF: 1007)

VERSION HISTORY

Here is a list of the features added to each manual reference.

Ref. 0601

The PCI central unit is removed from the manual.
New monitor LCD-15".

Ref. 0609

The floppy disk unit with USB connectors is removed from the manual.
Remote modules (bus CAN with CANopen protocol).

Ref. 0705

ICU central unit.
MCU central unit.
15" passive screen.

Ref. 0706

Corrected the numbering of the pinout of "Phoenix Contact" connectors

Ref. 0710 / Ref. 0801

The handwheel module with the E-stop button has been removed from the manual.

Ref. 0804

Corrected mouse dimensions.

Ref. 0809

The PC104 central unit is removed from the manual.
The VGA cable for passive screens is valid for cable carrying chains.
The remote modules with CANopen are now called RIOW5 remote modules.
The remote modules with CANfagor are now called RIOW70 remote modules.
New RIOW remote modules.

Ref. 0907

Corrected errors. Remote modules RIOW and RIO5 cannot handle a probe.
RS485 pinout correction.
Mechatrolink bus.
PCI expansion module for MCU central unit.

Ref. 1007

Corrected errors. Position of the dip-switches for selecting the speed in the CAN bus with CANopen protocol, in the OP-PANEL-HE and Jog-Panel.

RIOW remote modules. The name of the RIOW-CANOPEN has been changed to RIOW-CANOPEN-ECO.

RIOW remote modules. New module RIOW-CANOPEN-STAND).

ICU - MCU central unit. Configure the serial line as RS232, RS422 or RS485.

RS485. At the line terminating resistor, pin 2 must NOT be jumpered with pins 7/9 nor pin 3 with pins 6/8

Thin Client



CNC 8070

(REF: 1007)

SAFETY CONDITIONS

Read the following safety measures in order to prevent harming people or damage to this product and those products connected to it. Fagor Automation shall not be held responsible of any physical damage or defective unit resulting from not complying with these basic safety regulations.



Before start-up, verify that the machine that integrates this CNC meets the 89/392/CEE Directive.

PRECAUTIONS BEFORE CLEANING THE UNIT

If the CNC does not turn on when actuating the start-up switch, verify the connections.

- Do not get into the inside of the unit.** Only personnel authorized by Fagor Automation may manipulate the inside of this unit.
- Do not handle the connectors with the unit connected to AC power.** Before manipulating the connectors (inputs/outputs, feedback, etc.) make sure that the unit is not connected to AC power.

PRECAUTIONS DURING REPAIR

In case of a malfunction or failure, disconnect it and call the technical service.

- Do not get into the inside of the unit.** Only personnel authorized by Fagor Automation may manipulate the inside of this unit.
- Do not handle the connectors with the unit connected to AC power.** Before manipulating the connectors (inputs/outputs, feedback, etc.) make sure that the unit is not connected to AC power.

PRECAUTIONS AGAINST PERSONAL DAMAGE

- Interconnection of modules.** Use the connection cables provided with the unit.
- Use proper cables.** To prevent risks, use the proper cables for mains, Sercos and Bus CAN recommended for this unit.
In order to avoid electrical shock at the central unit, use the proper power (mains) cable. Use 3-wire power cables (one for ground connection).
- Avoid electrical overloads.** In order to avoid electrical discharges and fire hazards, do not apply electrical voltage outside the range selected on the rear panel of the central unit.
- Ground connection.** In order to avoid electrical discharges, connect the ground terminals of all the modules to the main ground terminal. Before connecting the inputs and outputs of this unit, make sure that all the grounding connections are properly made.
In order to avoid electrical shock, before turning the unit on verify that the ground connection is properly made.
- Do not work in humid environments.** In order to avoid electrical discharges, always work under 90% of relative humidity (non-condensing) and 45 °C (113 °F).
- Do not work in explosive environments.** In order to avoid risks or damages, do no work in explosive environments.



CNC 8070

(REF: 1007)

PRECAUTIONS AGAINST PRODUCT DAMAGE

Working environment.	This unit is ready to be used in industrial environments complying with the directives and regulations effective in the European Community. Fagor Automation shall not be held responsible for any damage suffered or caused by the CNC when installed in other environments (residential or homes).
Install the unit in the right place.	It is recommended, whenever possible, to install the CNC away from coolants, chemical product, blows, etc. that could damage it. This unit complies with the European directives on electromagnetic compatibility. Nevertheless, it is recommended to keep it away from sources of electromagnetic disturbance such as: <ul style="list-style-type: none"> Powerful loads connected to the same AC power line as this equipment. Nearby portable transmitters (Radio-telephones, Ham radio transmitters). Nearby radio/TV transmitters. Nearby arc welding machines. Nearby High Voltage power lines.
Enclosures.	The manufacturer is responsible of assuring that the enclosure involving the equipment meets all the currently effective directives of the European Community.
Avoid disturbances coming from the machine.	The machine must have all the interference generating elements (relay coils, contactors, motors, etc.) uncoupled.
Use the proper power supply.	Use an external regulated 24 Vdc power supply for the keyboard and the remote modules.
Grounding of the power supply.	The zero volt point of the external power supply must be connected to the main ground point of the machine.
Analog inputs and outputs connection.	Use shielded cables connecting all their meshes to the corresponding pin.
Ambient conditions.	The storage temperature must be between +5 °C and +45 °C (41 °F and 113 °F). The storage temperature must be between -25 °C and 70 °C (-13 °F and 158 °F).
Central unit enclosure.	Make sure that the needed gap is kept between the central unit and each wall of the enclosure. Use a DC fan to improve enclosure ventilation.
Main AC power switch.	This switch must be easy to access and at a distance between 0.7 and 1.7 m (2.3 and 5.6 ft) off the floor.

PROTECTIONS OF THE UNIT ITSELF

Remote modules.	All the digital inputs and outputs have galvanic isolation via optocouplers between the CNC circuitry and the outside.
------------------------	--



CNC 8070

(REF: 1007)

SAFETY SYMBOLS

Symbols that may appear on the manual.



Danger or prohibition symbol.

It indicates actions or operations that may hurt people or damage products.



Warning symbol.

It indicates situations that certain operations could cause and the suggested actions to prevent them.



Obligation symbol.

It indicates actions and operations that must be carried out.



Information symbol.

It indicates notes, warnings and advises.

Symbols that the product may carry.



Ground protection symbol.

It indicates that that point must be under voltage.

WARRANTY TERMS

INITIAL WARRANTY

All products manufactured or marketed by FAGOR carry a 12-month warranty for the end user which could be controlled by the our service network by means of the warranty control system established by FAGOR for this purpose.

In order to prevent the possibility of having the time period from the time a product leaves our warehouse until the end user actually receives it run against this 12-month warranty, FAGOR has set up a warranty control system based on having the manufacturer or agent inform FAGOR of the destination, identification and on-machine installation date, by filling out the document accompanying each FAGOR product in the warranty envelope. This system, besides assuring a full year of warranty to the end user, enables our service network to know about FAGOR equipment coming from other countries into their area of responsibility.

The warranty starting date will be the one appearing as the installation date on the above mentioned document. FAGOR offers the manufacturer or agent 12 months to sell and install the product. This means that the warranty starting date may be up to one year after the product has left our warehouse so long as the warranty control sheet has been sent back to us. This translates into the extension of warranty period to two years since the product left our warehouse. If this sheet has not been sent to us, the warranty period ends 15 months from when the product left our warehouse.

This warranty covers all costs of material and labour involved in repairs at FAGOR carried out to correct malfunctions in the equipment. FAGOR undertakes to repair or replace their products within the period from the moment manufacture begins until 8 years after the date on which it disappears from the catalogue.

It is entirely up to FAGOR to determine whether the repair is or not under warranty.

EXCLUDING CLAUSES

Repairs will be carried out on our premises. Therefore, all expenses incurred as a result of trips made by technical personnel to carry out equipment repairs, despite these being within the above-mentioned period of warranty, are not covered by the warranty.

Said warranty will be applied whenever the equipment has been installed in accordance with instructions, has not be mistreated, has not been damaged by accident or by negligence and has not been tampered with by personnel not authorised by FAGOR. If, once servicing or repairs have been made, the cause of the malfunction cannot be attributed to said elements, the customer is obliged to cover the expenses incurred, in accordance with the tariffs in force.

Other warranties, implicit or explicit, are not covered and FAGOR AUTOMATION cannot be held responsible for other damages which may occur.



CNC 8070

(REF: 1007)

WARRANTY ON REPAIRS

In a similar way to the initial warranty, FAGOR offers a warranty on standard repairs according to the following conditions:

PERIOD	12 months.
CONCEPT	Covers parts and labor for repairs (or replacements) at the network's own facilities.
EXCLUDING CLAUSES	The same as those applied regarding the chapter on initial warranty. If the repair is carried out within the warranty period, the warranty extension has no effect.

When the customer does not choose the standard repair and just the faulty material has been replaced, the warranty will cover just the replaced parts or components within 12 months.

For sold parts the warranty is 12 months length.

SERVICE CONTRACTS

The SERVICE CONTRACT is available for the distributor or manufacturer who buys and installs our CNC systems.



CNC 8070

(REF: 1007)

MATERIAL RETURNING TERMS

When sending the central nit or the remote modules, pack them in its original package and packaging material. If the original packaging material is not available, pack it as follows:

- 1 Get a cardboard box whose three inside dimensions are at least 15 cm (6 inches) larger than those of the unit. The cardboard being used to make the box must have a resistance of 170 Kg (375 lb.).
- 2 Attach a label indicating the owner of the unit, person to contact, type of unit and serial number. In case of malfunction also indicate symptom and a brief description of the problem.
- 3 Wrap the unit in a polyethylene roll or similar material to protect it. When sending a central unit with monitor, protect especially the screen.
- 4 Pad the unit inside the cardboard box with poly-utherane foam on all sides.
- 5 Seal the cardboard box with packing tape or industrial staples.

CNC MAINTENANCE

CLEANING

The accumulated dirt inside the unit may act as a screen preventing the proper dissipation of the heat generated by the internal circuitry which could result in a harmful overheating of the unit and, consequently, possible malfunctions. Accumulated dirt can sometimes act as an electrical conductor and short-circuit the internal circuitry, especially under high humidity conditions.

To clean the operator panel and the monitor, a smooth cloth should be used which has been dipped into de-ionized water and /or non abrasive dish-washer soap (liquid, never powder) or 75° alcohol. Do not use highly compressed air to clean the unit because it could generate electrostatic discharges.

The plastics used on the front panel are resistant to grease and mineral oils, bases and bleach, dissolved detergents and alcohol. Avoid the action of solvents such as chlorine hydrocarbons, venzole, esters and ether which can damage the plastics used to make the unit's front panel.



PRECAUTIONS BEFORE CLEANING THE UNIT

Fagor Automation shall not be held responsible for any material or physical damage derived from the violation of these basic safety requirements.

- Do not handle the connectors with the unit connected to AC power. Before handling these connectors (I/O, feedback, etc.), make sure that the unit is not connected to main AC power.
- Do not get into the inside of the unit. Only personnel authorized by Fagor Automation may manipulate the inside of this unit.
- If the CNC does not turn on when actuating the start-up switch, verify the connections.

RELATED DOCUMENTATION

Here is a list of the manuals available for your CNC and the languages. All the manuals are available on our corporate website and some of them may be found in the CD-Rom that comes with the product. Some of these manuals are also available in paper upon request.

Name and description.	WEB		
Hardware configuration (-M- / -T- / -BL- / -OL- model) This manual describes the hardware configuration and the technical data of each element.	Spanish / English		---
Installation manual (-M- / -T- / -BL- / -OL- model) This manual describes how to install and set the CNC up.	Spanish / English		
Operating manual (-M- / -T- / -BL- / -OL- model) This manual describes how to operate the CNC.	Spanish / English Italian / French German / Brazilian		
Programming manual (-M- / -T- / -BL- / -OL- model) This manual describes how to program the CNC.	Spanish / English Italian / French German / Brazilian		
Probing (-M-model) This manual describes how to program probing movements and probing canned cycles. Milling model.	Spanish / English Italian / French German / Brazilian		---
Probing (-T-model) This manual describes how to program probing movements and probing canned cycles. Lathe model.	Spanish / English Italian / French German		---
Machining canned cycles (-M- / -OL- model) This manual describes how to program the machining canned cycles. Milling model.	Spanish / English Italian / French German / Brazilian		
Machining canned cycles (-T- model) This manual describes how to program the machining canned cycles. Lathe model.	Spanish / English Italian / French / German		
Quick reference (-M- / -T- model) Summary guide of the PLC programming language.	Spanish / English Italian / French German		---
Programming examples (-M- model) Manual with programming examples for the mill model.	Spanish / English		---
Programming examples (-T- model) Manual with programming examples for the lathe model.	Spanish / English		---
Error solving manual (-M- / -T- / -BL- / -OL- model) This manual offers a description of some error messages that may appear on the CNC indicating the probable causes that originate them and how to solve them.	Spanish / English		---
Execution channels (-M- / -T- / -OL- model) This manual describes how to configure and work in a multi-channel system.	Spanish / English Italian / French German / Brazilian		
Monographic subjects (-M- / -T- / -BL- / -OL- model) This manual describes how to configure and work with some CNC features.	Spanish / English Italian / French German		

FAGOR 

CNC 8070

(REF: 1007)

1 PREVIOUS INFORMATION.

About this manual.

This manual describes the characteristics, technical data and connections of the hardware associated with the CNC. The installation manual describes the CNC configuration, machine adaptation and start-up. The installation CD that comes with the unit has the necessary documentation to install, set up and operate the unit.

Installation and startup.

The hardware described in this manual is ready to be used in industrial environments complying with the directives and regulations effective in the European Community. Before start-up, verify that the machine that integrates this CNC meets the 89/392/CEE directive.

Safety conditions.

In order to avoid personal injuries and damage to this product or to those connected to it, read carefully the section on safety conditions in the introduction to this manual. Fagor Automation shall not be held responsible of any physical damage or defective unit resulting from not complying with these basic safety regulations.



Do not handle the connectors with the unit connected to AC power. Before doing it, make sure that the unit is unplugged from the power outlet.



Do not get into the inside of the unit. This unit MUST NOT be opened by unauthorized personnel. Only personnel authorized by Fagor Automation may manipulate the inside of this unit.

1.**PREVIOUS INFORMATION.****FAGOR** **CNC 8070**

(REF: 1007)

2 HARDWARE STRUCTURE.

Central unit, monitor, keyboard and operator panel.

The central unit MCU is designed to be installed in the cabinet, it is not coupled to any monitor. The central unit ICU is located on the rear of the monitor. Both units have a VGA output to connect the passive monitor LCD15SVG or an off-the-shelf monitor.

Depending on the CNC model, it may have either a keyboard module and an operator panel module or a module that combines both. There is also a CNC model that has the keyboard and the operator panel into the monitor.

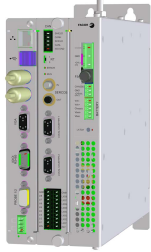
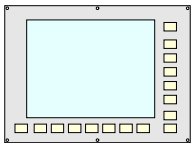
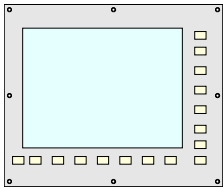
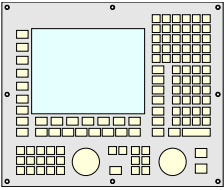
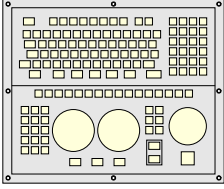
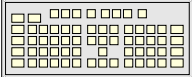
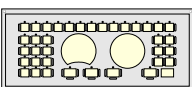
identification.		Description.
	MCU	MCU central unit.
	LCD10	ICU central unit. 10" LCD monitor.
	LCD15	ICU central unit. 15" LCD monitor.
	LCD10K	ICU central unit. 10" LCD monitor with integrated keyboard and operator panel.
	OP-PANEL-HE	Keyboard with integrated operator panel. Available either with an electronic handwheel (OP-Panel-H) or with an emergency stop button (OP-Panel-E).
	KB-PANEL-H	Keyboard.
	JOG-PANEL	Operator panel.

2.

HARDWARE STRUCTURE.



CNC 8070

(REF: 1007)

Passive screen.

The passive screen may be used to display the video signal coming from the ·VGA· connector of the central unit and also interact with the central unit using softkeys. This screen may be the only one connected to the central unit (for example, with the central unit MCU) or it may be a second monitor (for example, with the central unit ICU). When the screen is used as a second monitor, both monitors show the same video signal.

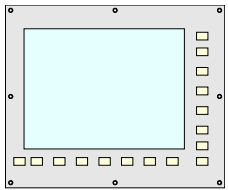
identification.	Description.
	LCD15SVGA 15" LCD passive monitor.

Remote modules.

Remote modules may be used to have an additional number of digital and analog inputs and outputs (remote I/O) that, distributed at different points of the machine or mounted in the cabinet, permit controlling various devices of the machine. The remote modules are distributed by groups (nodes) and are connected to the central unit through the CAN bus that can have up to 32 nodes, including the central unit and the keyboards.

The CNC has remote modules for CANfagor bus (RIO70 series) and for CANopen bus (series RIO5 and RIOW) When the CNC works with CANopen bus, this bus lets combine in the bus groups (nodes) formed by RIO5 and RIOW series modules; modules of both series cannot be combined in the same group.

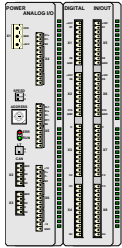
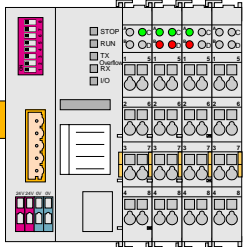
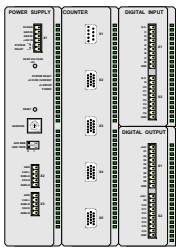
identification.	Description.
	RIO5 Remote modules (CANopen protocol). <ul style="list-style-type: none"> • Digital inputs and outputs. • General purpose analog inputs and outputs. • Analog inputs for PT100 temperature sensors.
	RIOW Remote modules (CANopen protocol). <ul style="list-style-type: none"> • Digital inputs and outputs. • General purpose analog inputs and outputs. • Analog inputs for PT100 temperature sensors.
	RIO70 Remote modules (CANfagor protocol). <ul style="list-style-type: none"> • Digital inputs and outputs. • General purpose analog inputs and outputs. • Feedback inputs.

2.



HARDWARE STRUCTURE.



CNC 8070

(REF: 1007)

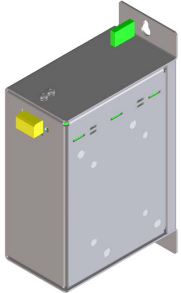
Additional hardware.

identification.	Description.
	<p>Emergency battery. The battery ensures the operation of the central unit against power failures and, if necessary, allows the CNC to execute the automatic shut-down sequence due to a power failure.</p>
	<p>Mouse.</p>

Off-the-shelf peripherals.

Peripherals such as floppy disk drives, CD-Rom drives or the mouse may be connected to the CNC using the specific cables supplied by their manufacturer.

2.

HARDWARE STRUCTURE.

2.1 Possible configurations.

The following description only refers to the central unit, keyboard and operator panel. The configuration of the rest of the elements, like the battery or the mouse, is described in their own chapters.

[ICU + LCD10] + [KB-PANEL-H] + [JOG-PANEL]

The central unit is located on the rear of the monitor. The keyboard and the operator panel are independent modules.

Basic connection.

- The keyboard is connected through the PS-2 port.
- The operator panel and the remote modules are connected through the CAN bus.
- The Sercos bus is used to communicate with digital Fagor drives. It is also possible to communicate with analog drives.

Remember that the ground terminals of all the elements making up the system must be connected to a single ground point.

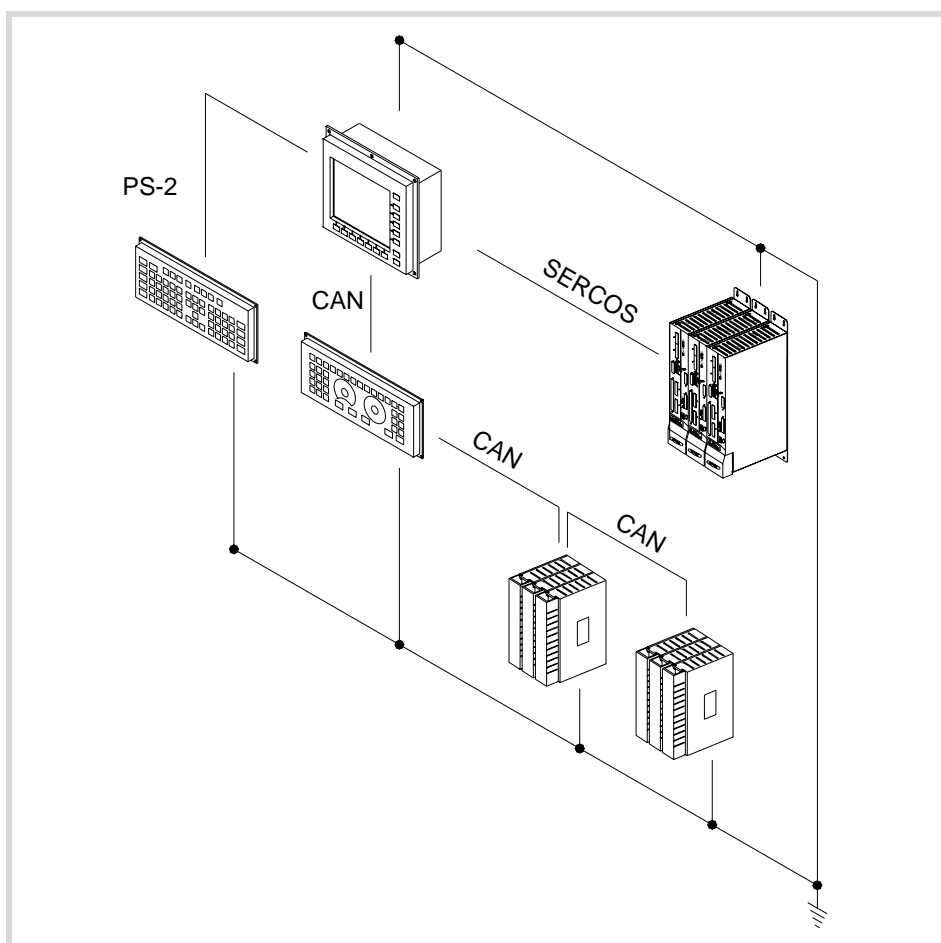

2.

HARDWARE STRUCTURE:

FAGOR 

CNC 8070

(REF: 1007)

[ICU + LCD10K]

The central unit is located on the rear of the monitor. The keyboard and the operator panel are integrated into the monitor.

Basic connection.

- The remote modules are connected through the CAN bus.
- The Sercos bus is used to communicate with digital Fagor drives. It is also possible to communicate with analog drives.

Remember that the ground terminals of all the elements making up the system must be connected to a single ground point.

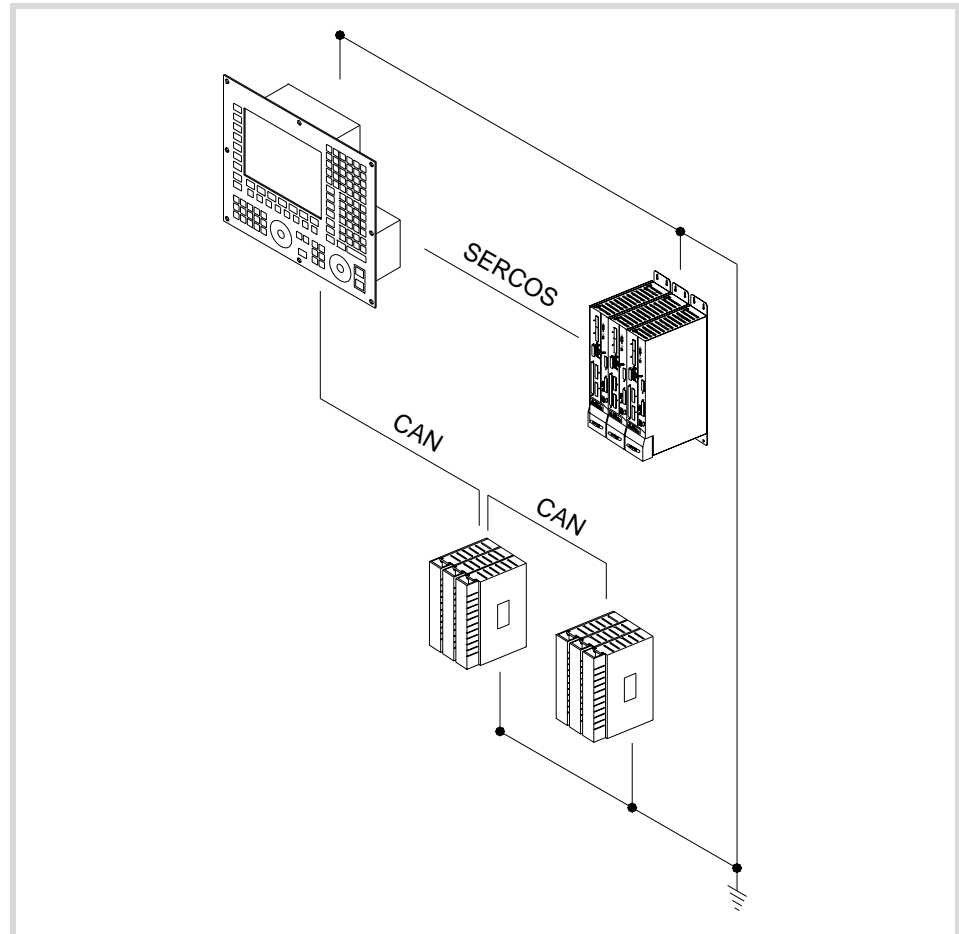
**2.****HARDWARE STRUCTURE.**

[ICU + LCD15] + [OP-PANEL-H/E]

The central unit is located on the rear of the monitor. The keyboard and the operator panel are a single module. The operator panel may have either an emergency button (E-stop) or a handwheel.

Basic connection.

- The keyboard module, operator panel and the remote modules are connected through the CAN bus.
- The Sercos bus is used to communicate with digital Fagor drives. It is also possible to communicate with analog drives.

Remember that the ground terminals of all the elements making up the system must be connected to a single ground point.

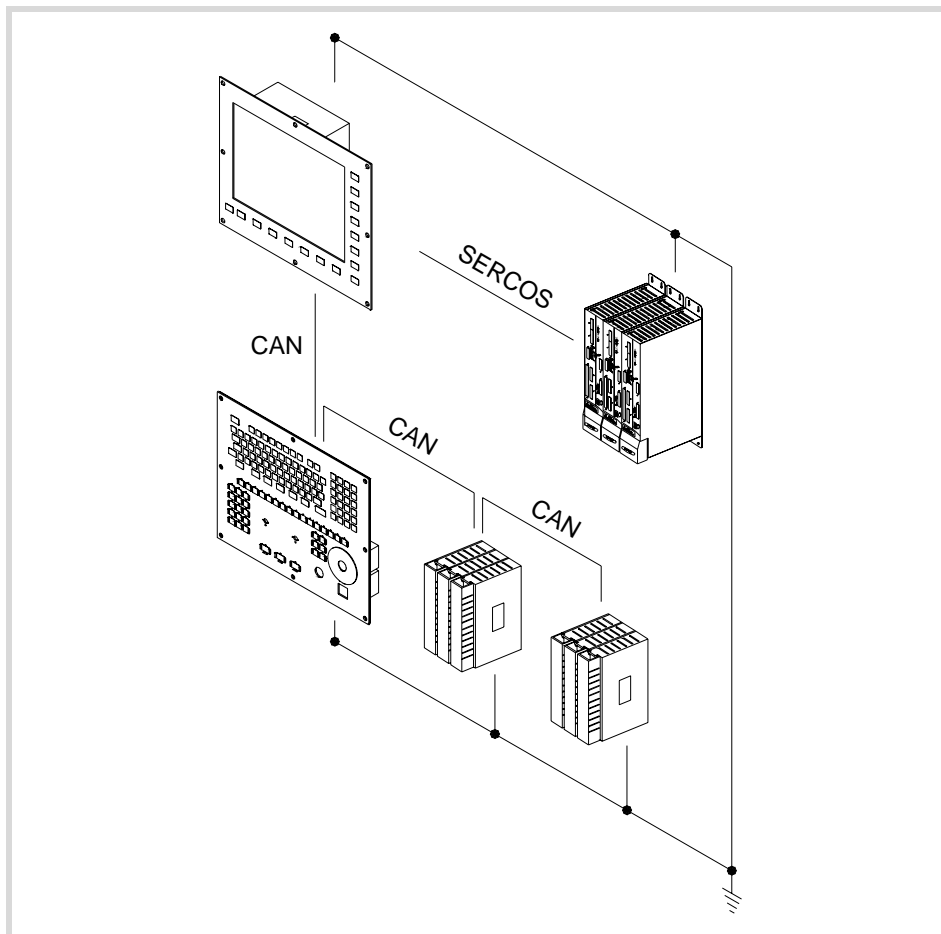
**2.****HARDWARE STRUCTURE:****FAGOR** **CNC 8070**

(REF: 1007)

[MCU] + [LCD15SVGA] + [OP-PANEL-H/E]

The central unit and the monitor are separate modules. The keyboard and the operator panel are a single module. The operator panel may have either an emergency button (E-stop) or a handwheel.

Basic connection.

- The central unit and the monitor are connected through the ·VGA· output.
- The keyboard module, operator panel and the remote modules are connected through the CAN bus.
- The Sercos bus is used to communicate with digital Fagor drives. It is also possible to communicate with analog drives.

Remember that the ground terminals of all the elements making up the system must be connected to a single ground point.

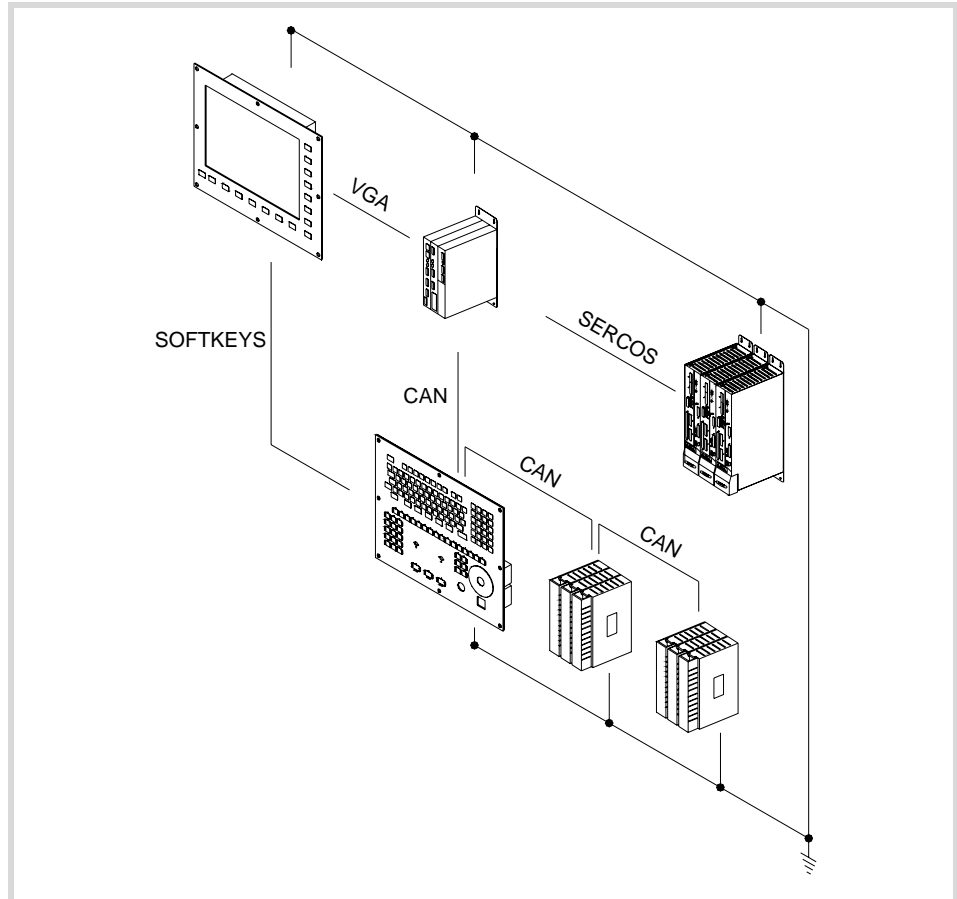
**2.****HARDWARE STRUCTURE.**

3 HEAT DISSIPATION. CENTRAL UNIT (CPU) ENCLOSURE.

The working temperature of the central unit enclosure must not exceed 45 °C (113°F). To ensure that it does not exceed this temperature, the enclosure must meet the following requirements.

- The enclosure must have enough surface inside to evacuate the heat generated inside and keep the ambient conditions within the working temperature range.
- The enclosure must respect the minimum distances recommended between the enclosure walls and the central unit to let the air flow and improve heat dissipation.

Minimum gaps recommended between the enclosure walls and the central unit.

To ensure that it does not exceed this temperature, respect the recommended minimum gap between the sides of the enclosure and the central unit.

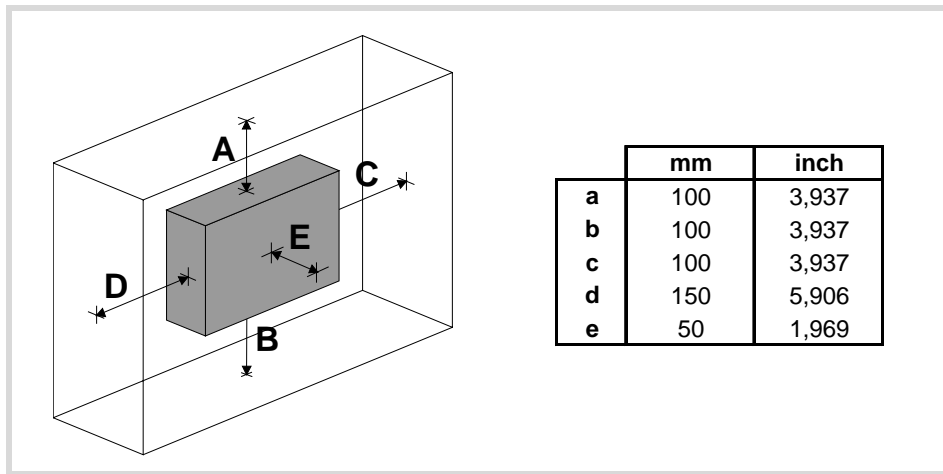

To ensure the required ambient conditions, the enclosure must have an air input next to the cables and an air output next to the fan. In this case, install fans to ventilate the enclosure and keep the temperature within the allowed limits.

Keep the enclosure clean. Anti-dust filters should be installed at the air inputs and outputs.

Understanding the calculation of the surface needed for heat dissipation.

The expressions have been obtained for an enclosure having a 2 mm wall and made out of aluminum. When using internal ventilation, the fan must be located 30 mm off the bottom.

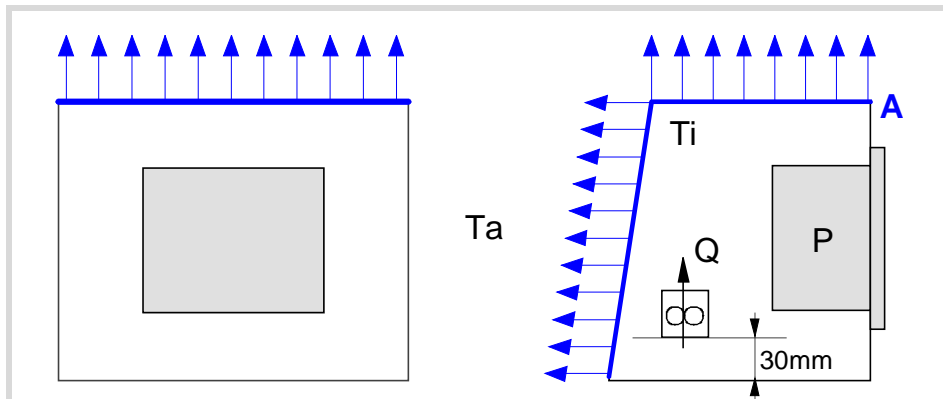

3.

HEAT DISSIPATION. CENTRAL UNIT (CPU) ENCLOSURE.



CNC 8070

(REF: 1007)

To calculate the total surface required for the enclosure, in order to dissipate the heat generated in it, the following data must be considered.

Data	Units	Meaning
A	(m ²)	Total surface needed.
P	(W)	Total power dissipated by all the elements that generate heat inside the enclosure, including the power supply and the fan, if there is one.
Ta	(°C)	Ambient temperature (outside the enclosure).
Ti	(°C)	Temperature inside the enclosure.
Δt	(°C)	Temperature difference (Ti-Ta).
Q	(m ³ /h)	Air flow provided by the fan, if there is one.

Dissipating surface.

Only surfaces dissipating heat by convection will be considered, the top and the rear of the enclosure. The rest of the surfaces are not to be considered when calculating the total surface.

Power dissipated by the CNC.

To calculate the dissipated power, all the elements that are inside the enclosure must be taken into account.

Element	Dissipated power
ICU central unit.	85 watts.

3.

HEAT DISSIPATION. CENTRAL UNIT (CPU) ENCLOSURE.

3.1 Heat dissipation models.

Heat dissipation by natural convection.

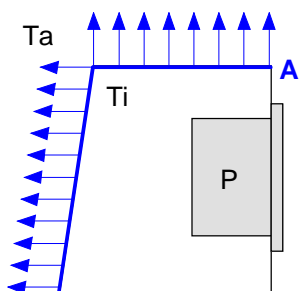

Unpainted surface.

$$A = \frac{P}{5 \cdot \Delta T}$$

Surface with smooth metallic enamel.

$$A = \frac{P}{5,7 \cdot \Delta T}$$

Heat dissipation by forced convection with internal fan.

Fan whose air flow Q = 13.6 m³/h facing down.

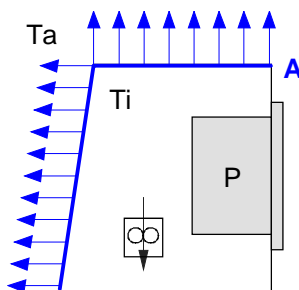

Unpainted surface.

$$A = \frac{P}{5,6 \cdot \Delta T}$$

Surface with smooth metallic enamel.

$$A = \frac{P}{7,6 \cdot \Delta T}$$

Fan whose air flow Q = 13.6 m³/h facing up.

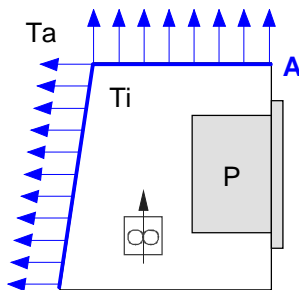

Unpainted surface.

$$A = \frac{P}{5,8 \cdot \Delta T}$$

Fan whose air flow Q = 30 m³/h facing down.

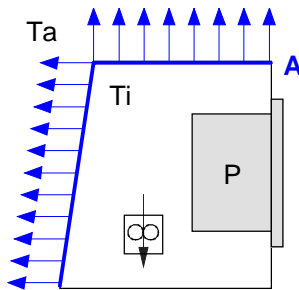

Unpainted surface.

$$A = \frac{P}{6,75 \cdot \Delta T}$$

Surface with smooth metallic enamel.

$$A = \frac{P}{9,1 \cdot \Delta T}$$

3.

HEAT DISSIPATION. CENTRAL UNIT (CPU) ENCLOSURE.

Fan whose air flow $Q = 102 \text{ m}^3/\text{h}$ facing down.

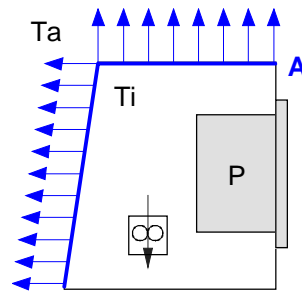

Unpainted surface.

$$A = \frac{P}{7,5 \cdot \Delta T}$$

Surface with smooth metallic enamel.

$$A = \frac{P}{9,8 \cdot \Delta T}$$

Heat dissipation by air flow to the outside using a fan.

Heat dissipation by forced convection with hot air flow to the outside using a fan and ambient air intake through the holes located at the bottom of the enclosure.

For this case, the volume of air flow is calculated necessary to evacuate the heat generated inside the enclosure. The fan's air flow is calculated according to the power dissipated by the CNC and the fan itself as well as the inside and outside temperatures.

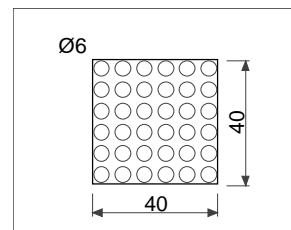

Unpainted surface.

$$V = \frac{3,8 \cdot P}{\Delta T}$$

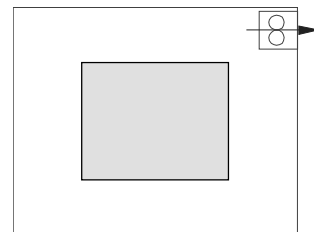

Bear in mind that this air flow through the unit extracts hot air to the outside, but it allows dirt into the enclosure. Thus, a filter should be installed to maintain the ambient conditions allowed.

3.

HEAT DISSIPATION. CENTRAL UNIT (CPU) ENCLOSURE.

4 CENTRAL UNITS ICU - MCU.

ICU central unit.

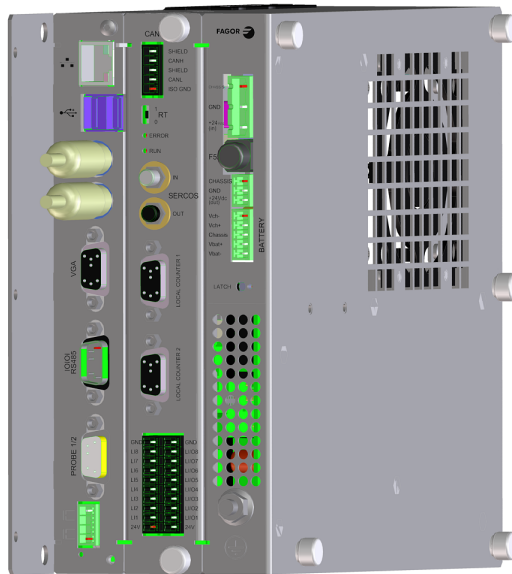

MCU central unit.

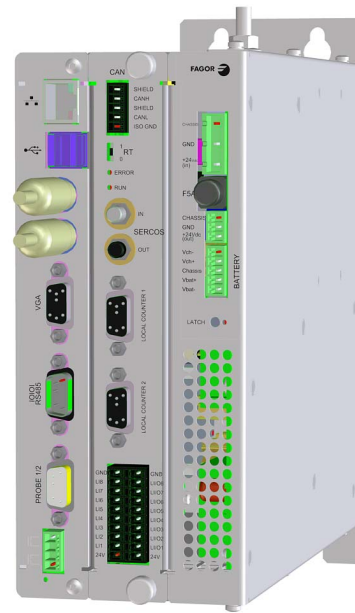

4.

CENTRAL UNITS ICU - MCU.

General characteristics.	ICU central unit.	MCU central unit.
Processor.	Pentium M 1.1 GHz	
RAM memory.	Minimum 512 Mb	
RAM memory with battery.	Yes	
Hard disk.	4 GB compact flash. Optional mechanical hard disk.	
Monitor.	10" LCD / 15" LCD	Without monitor.
Battery of the CMOS.	CR2450 (access from the outside)	

Communications/connection.	ICU central unit.	MCU central unit.
Ethernet.	T base 10/100	
USB.	2 USB 2.0 channels	
Serial line.	1 RS485 serial line (115 Kbaud)	
CAN bus.	Communication with the remote modules.	
Sercos Bus.	Communication with Fagor drives.	
Mechatrolink bus.	Communication with Mechatrolink devices (servos and inverters).	
Standard peripherals.	PC-compatible keyboard. Mouse with PS-2 connector.	
Video output.	1 VGA output	
PCI port	No	Yes (optional)

Inputs/outputs.	ICU central unit.	MCU central unit.
Digital inputs/outputs.	8 digital inputs. 8 digital inputs or outputs (configurable).	
Feedback inputs.	2 feedback inputs (TTL, differential TTL)	
Emergency relay.	1 relay with two normally open contacts (1 A at 24 V).	
Probe inputs.	2 probes (5 V or 24 V)	



CNC 8070

(REF: 1007)

Voltage supply for the central unit.

Universal DC power supply. Use a 24 V DC $\pm 10\%$ 3.5 A power supply. See ["4.7 Power connection."](#) on page 64.

Optionally, an external battery may be connected to ensure that the unit is properly powered off when detecting supply voltage outages. The battery provides an autonomy of about 20 minutes when it is fully charged.

Battery-powered RAM memory (non-volatile RAM).



Saving data in the battery-powered RAM required version V3.14 or higher.

The CNC has battery-powered RAM memory that keeps the information saved in it even when a power failure occurs. The RAM memory is powered by a 3 V CR2450 battery that may be accessed from the outside. See ["4.8 housing for the compact flash and battery-powered RAM memory."](#) on page 65.

The RAM memory with battery always saves the position of the axes, the rest of the data that it saves is determined by machine parameters, like for example, PLC registers (parameter BKUPREG), common arithmetic parameters (parameter BKUPCUP), etc.

Available monitors.

LCD monitors attached to the central unit ICU.

The central unit is located on the rear of the monitor and may be the following sizes.

Name.	Description.
LCD-10	10" LCD monitor (18-bit color). Resolution 800x600.
LCD-10K	10" LCD monitor (18-bit color) with keyboard and integrated operator panel. Resolution 800x600.
LCD-15	15" LCD monitor (18-bit color). Resolution 1024x768.

Passive LCD monitor.

LCD monitor with softkeys that is connected to the central unit through the ·VGA· output.

Name.	Description.
LCD-15SVGA	15" LCD passive monitor (18-bit color). Resolution 1024x768.

Off-the-shelf VGA monitor.

An off-the-shelf VGA monitor may be connected to the ICU central unit and to the MCU, but its cable cannot exceed 10 meters.

4.

4.1 Technical characteristics.

Electrical characteristics.

- Universal DC power supply.
Use a 24 Vdc $\pm 10\%$ 3.5 A power supply. Current peak of 90 A on power-up.

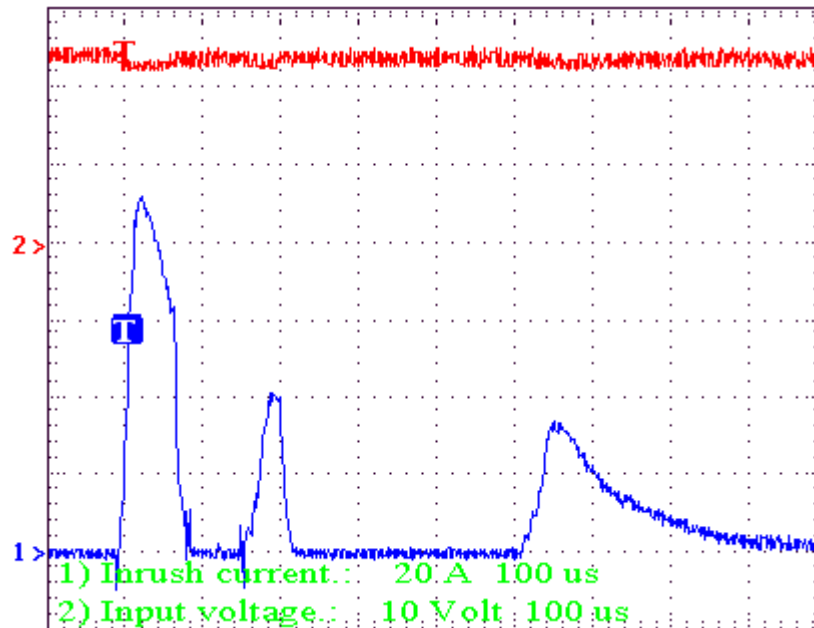

- Protection against over-voltage and reverse voltage.
The central unit has a fuse that may be accessed from the outside to protect against over-voltage (greater than 36 V DC or 25 V AC). The central unit is also protected against reverse connection of the power supply, preventing it from starting up.
- Protection against over-current.
An over-current activates the safety device inside the power supply. The central unit has an LED that turns on when this device is active.
To reactivate the power supply after an over-current, just press the button for it or turn it off for 30 seconds. If the led comes back on, call the Technical Service.
- Power outages.
Meets the EN 61000-4-11 regulation. The central unit is capable of withstanding micro-outages of up to 10 milliseconds.

Vibrations.

- Sweep sine trial with a frequency step of 1 octave/minute ($\pm 10\%$) and 10 sweeps long.
9 Hz $\geq f \geq$ 5 Hz Constant movement with an amplitude of 3 mm.
200 Hz $\geq f \geq$ 9 Hz Constant 1g acceleration.

Packaging and resistance to falls.

- Packaging: Meets the EN 60068-2-32 regulation.
- Free fall packaged according to Fagor regulations (1 meter):

4.

CENTRAL UNITS ICU - MCU.

FAGOR 

CNC 8070

(REF: 1007)

Ambient conditions.

- Relative humidity: 20-85% without condensation.
- Work temperature: 0-55 °C with an average lower than 35 °C.
- Storage temperature: Between -40 °C (77 °F) and +70 °C (158 °F).
- Maximum work altitude: Meets the IEC 1131-2 standard.

Degree of protection.

- Front panel: It meets the protection standard IP 56.
- Rear panel: It meets the protection standard IP 20.

The machine manufacturer must comply with the EN 60204-1 (IEC-204-1) regulation regarding electrical shocks in case of defective input/output pins with external power supply when not plugging the connector before turning the power supply on.



*Do not get into the inside of the unit. This unit **MUST NOT** be opened by unauthorized personnel. Only personnel authorized by Fagor Automation may manipulate the inside of this unit.*

4.

CENTRAL UNITS ICU - MCU.

4.2 MCU central unit dimensions.

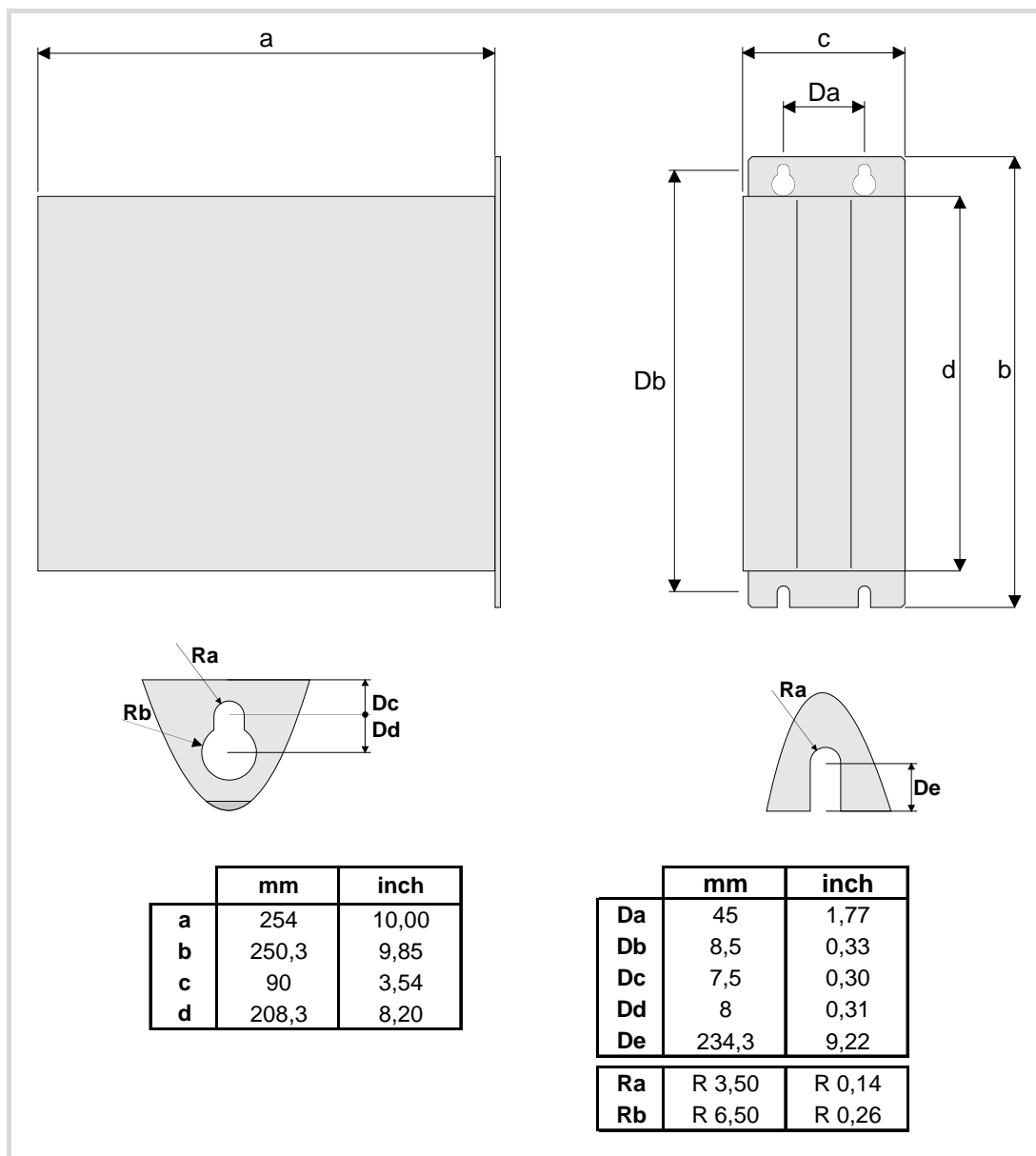

4.

CENTRAL UNITS ICU - MCU.

FAGOR 

CNC 8070

(REF: 1007)

4.3 MCU-PCI central unit dimensions.

4.

CENTRAL UNITS ICU - MCU.

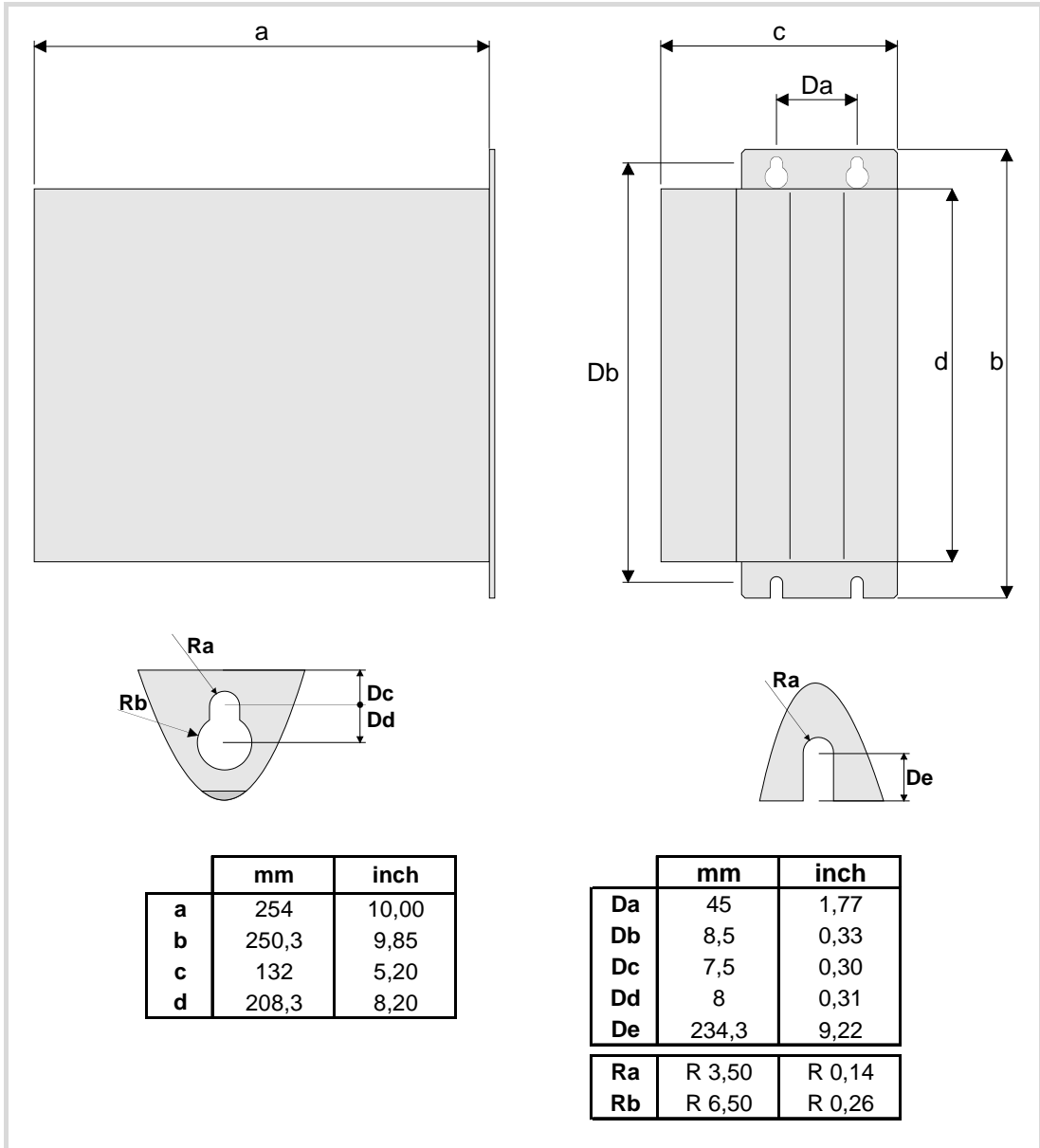

CNC 8070

(REF: 1007)

4.4 ICU central unit dimensions.

4.4.1 Dimensions of the central unit without monitor.

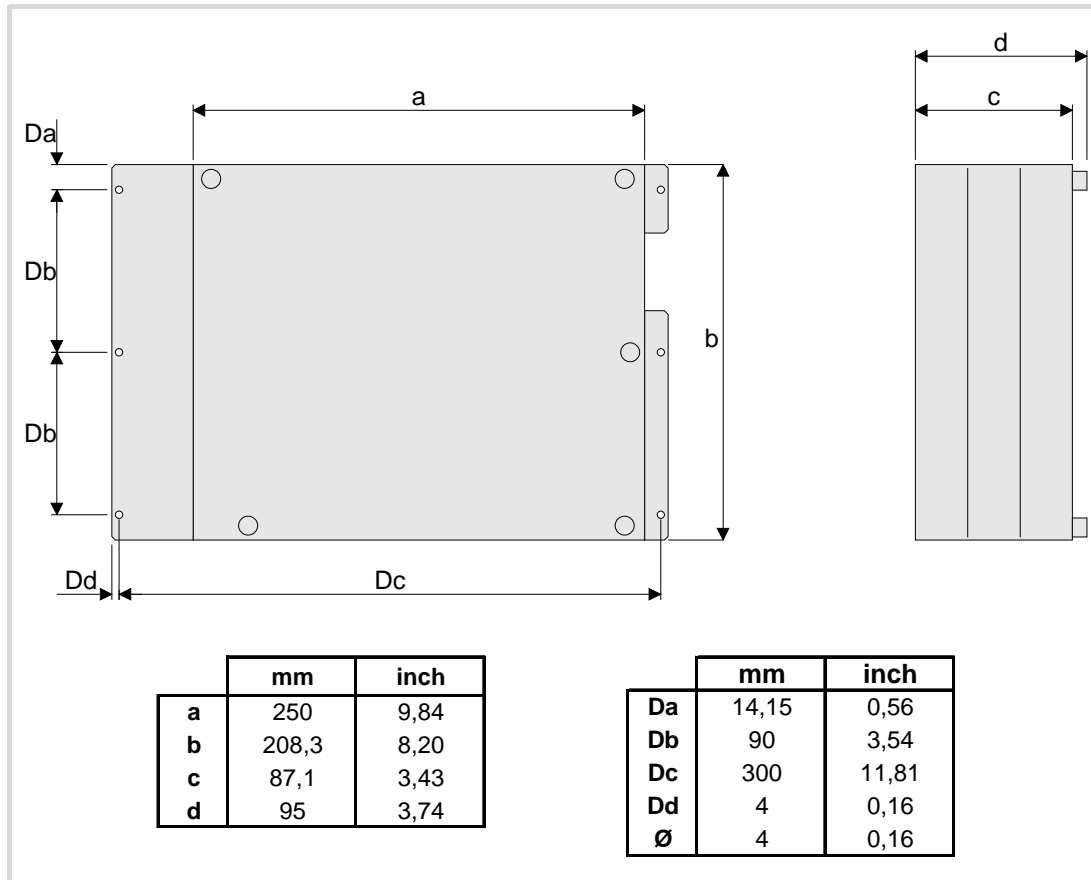

4.

CENTRAL UNITS ICU - MCU.

4.4.2 Dimensions of the central unit with LCD-10 monitor.

4.

CENTRAL UNITS ICU - MCU.

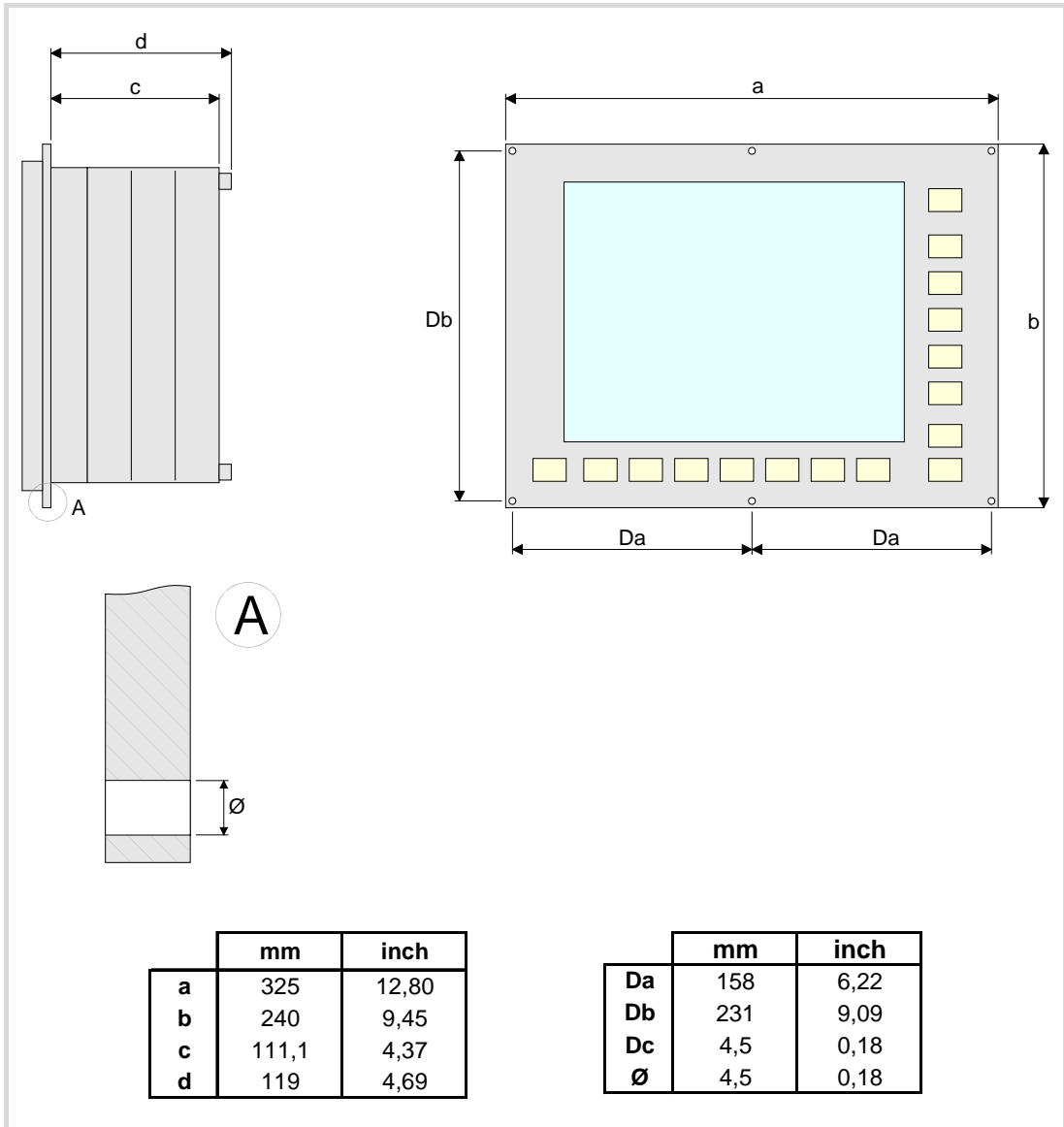

CNC 8070

(REF: 1007)

4.4.3 Dimensions of the central unit with LCD-10K monitor.

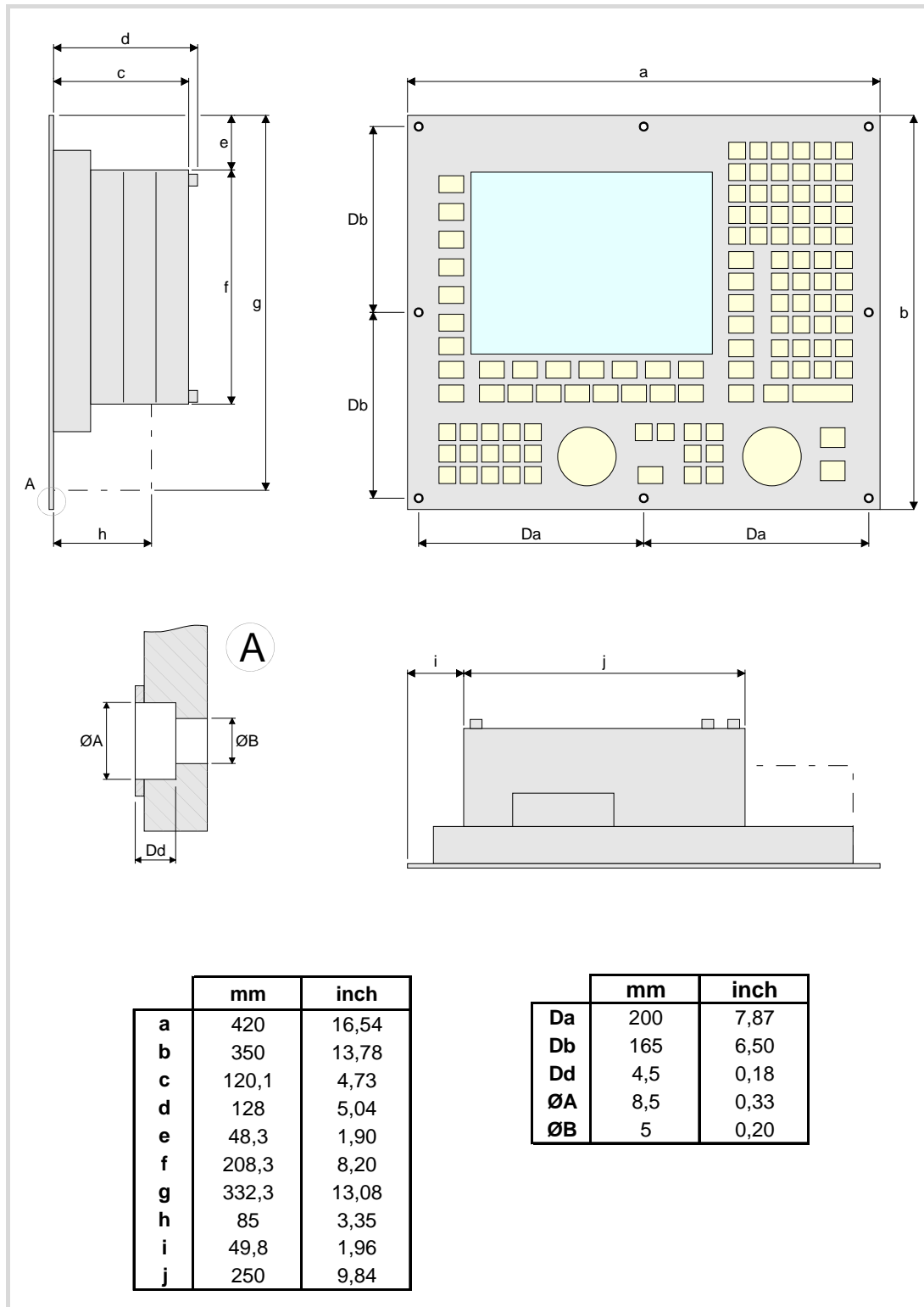

4.

CENTRAL UNITS ICU - MCU.



CNC 8070

(REF: 1007)

4.4.4 Dimensions of the central unit with LCD-15 monitor.

4.

CENTRAL UNITS ICU - MCU.

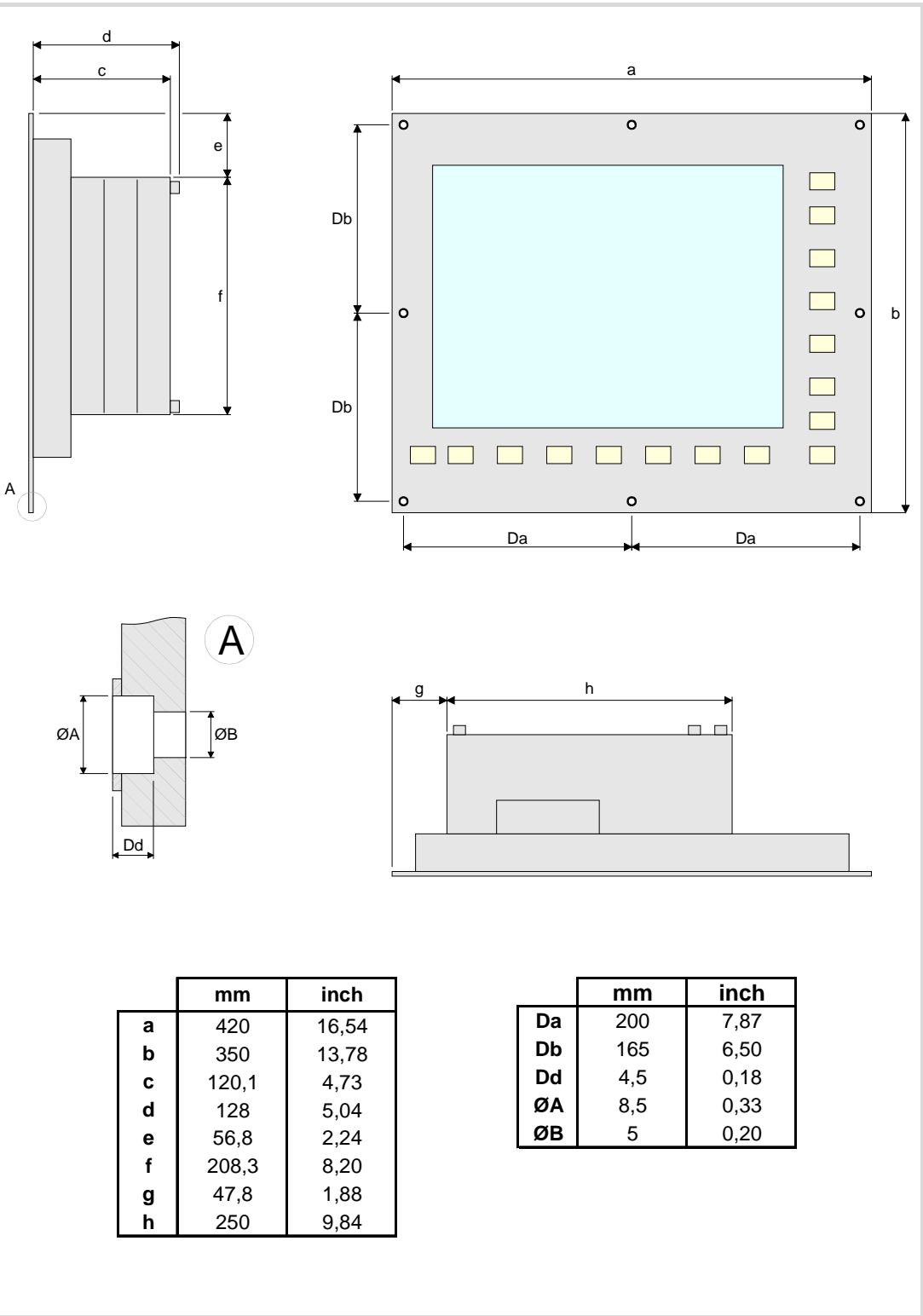

CNC 8070

(REF: 1007)

4.5 Dimensions and characteristics of the enclosure.

Ambient characteristics of the enclosure.

The working temperature of the central unit enclosure must not exceed 45 °C (113°F). To ensure that it does not exceed this temperature, the enclosure must meet the following requirements. See chapter "3 Heat dissipation. Central unit (cpu) enclosure."

- The enclosure must have enough surface inside to evacuate the heat generated inside and keep the ambient conditions within the working temperature range.
- The enclosure must respect the minimum distances recommended between the enclosure walls and the central unit.

Room reserved for cables.

Reserve some room for the cables in the connector area. This space makes it possible to bend the cables for the CPU connection with the recommended bending radius. Special care must be taken with the Sercos connection because bending the optic fiber too much could break it.

Fastening the unit (ICU central unit).

The central unit must be installed in a proper enclosure that may be located on the machine or on an external support. To insert the unit into the enclosure, it must have a big enough hole to allow to insert it easily, without obstacles and without forcing the unit.

Once the unit has been inserted into the enclosure, secure it from the outside with M4 or UNC8 screws. To properly secure it, use the mounting holes on the front panel of the unit.

Central unit with LCD-10 monitor.

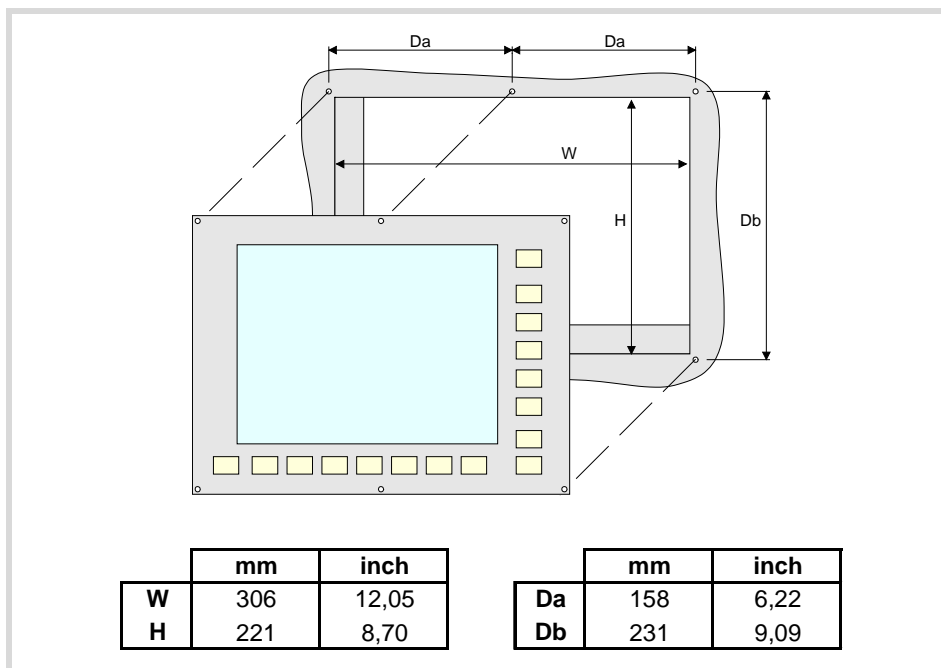

4.

CENTRAL UNITS ICU - MCU.

FAGOR 

CNC 8070

(REF: 1007)

Central unit with LCD-10K monitor.

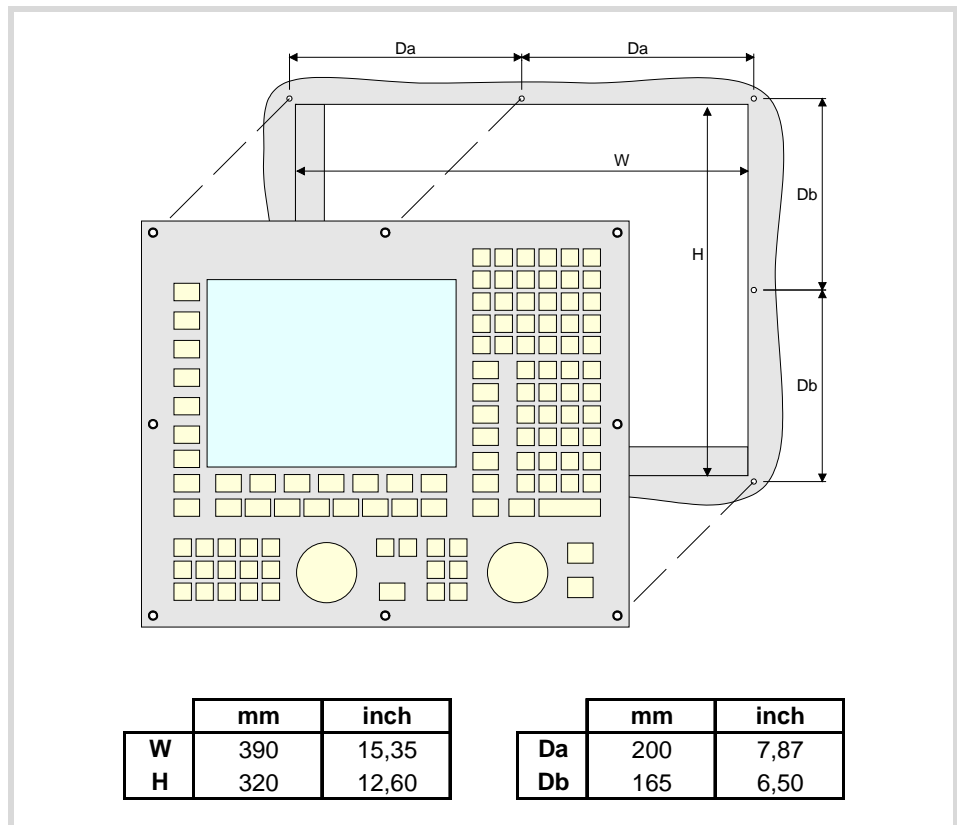

Central unit with LCD-15 monitor.

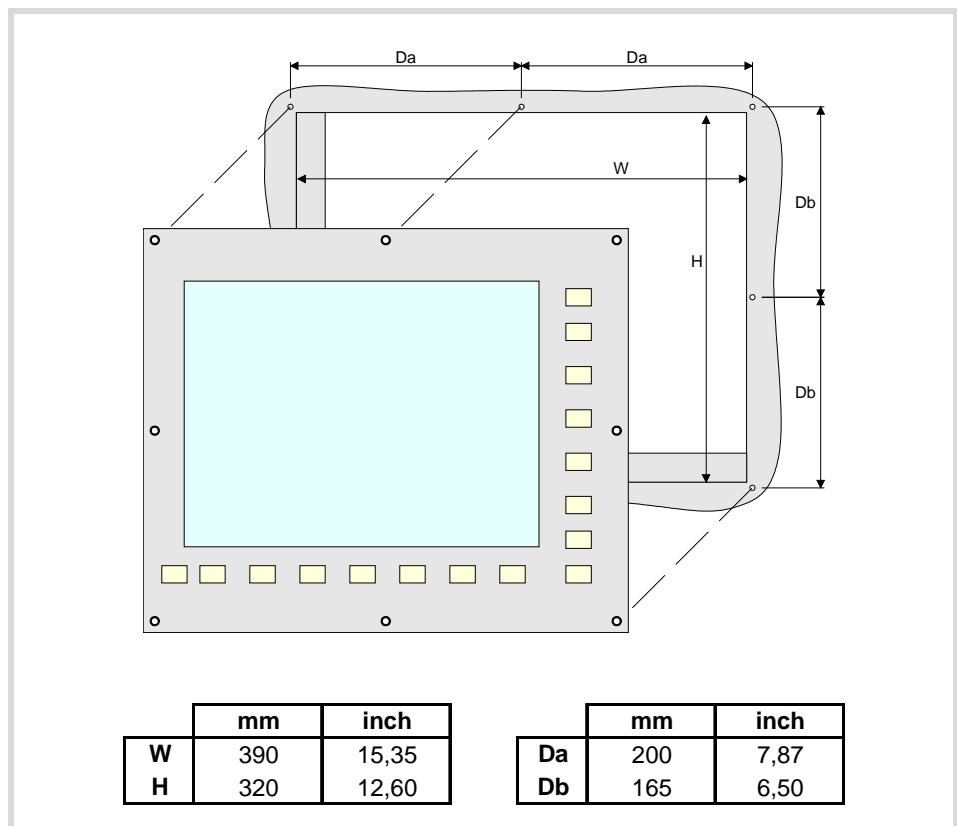

4.

CENTRAL UNITS ICU - MCU.



CNC 8070

(REF: 1007)

Fastening the unit (MCU central unit).

The central unit must go in a cabinet To properly secure it, use the mounting holes on the front panel of the unit.

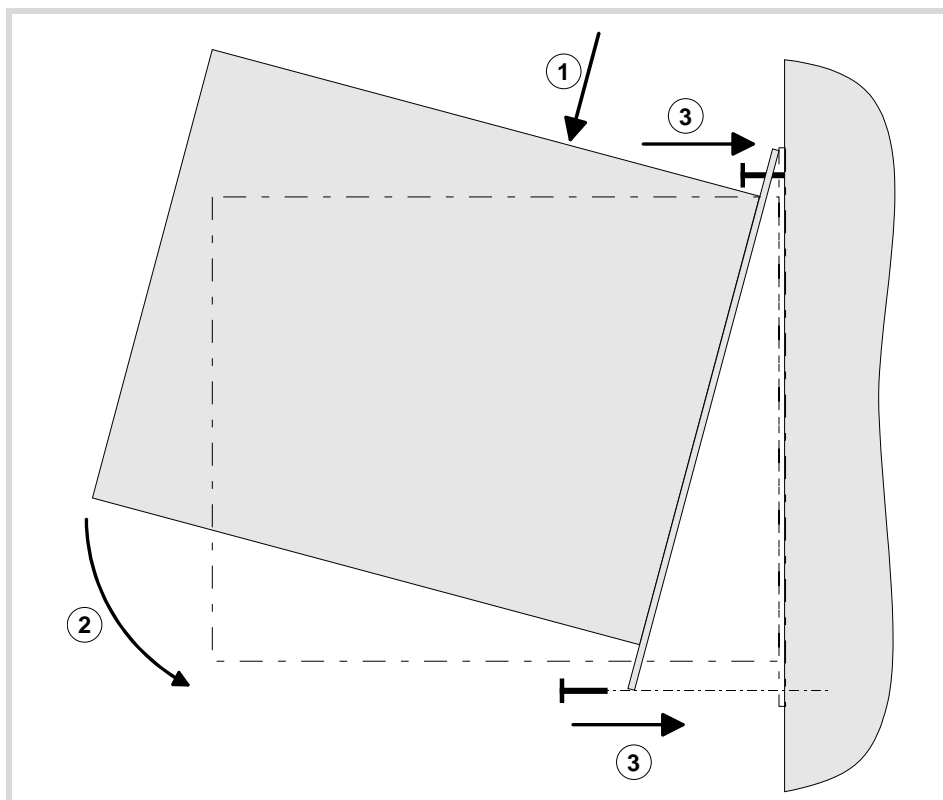

4.

CENTRAL UNITS ICU - MCU.

FAGOR 

CNC 8070

(REF: 1007)

4.6 Elements (connectors).

4.6.1 Peripheral board.

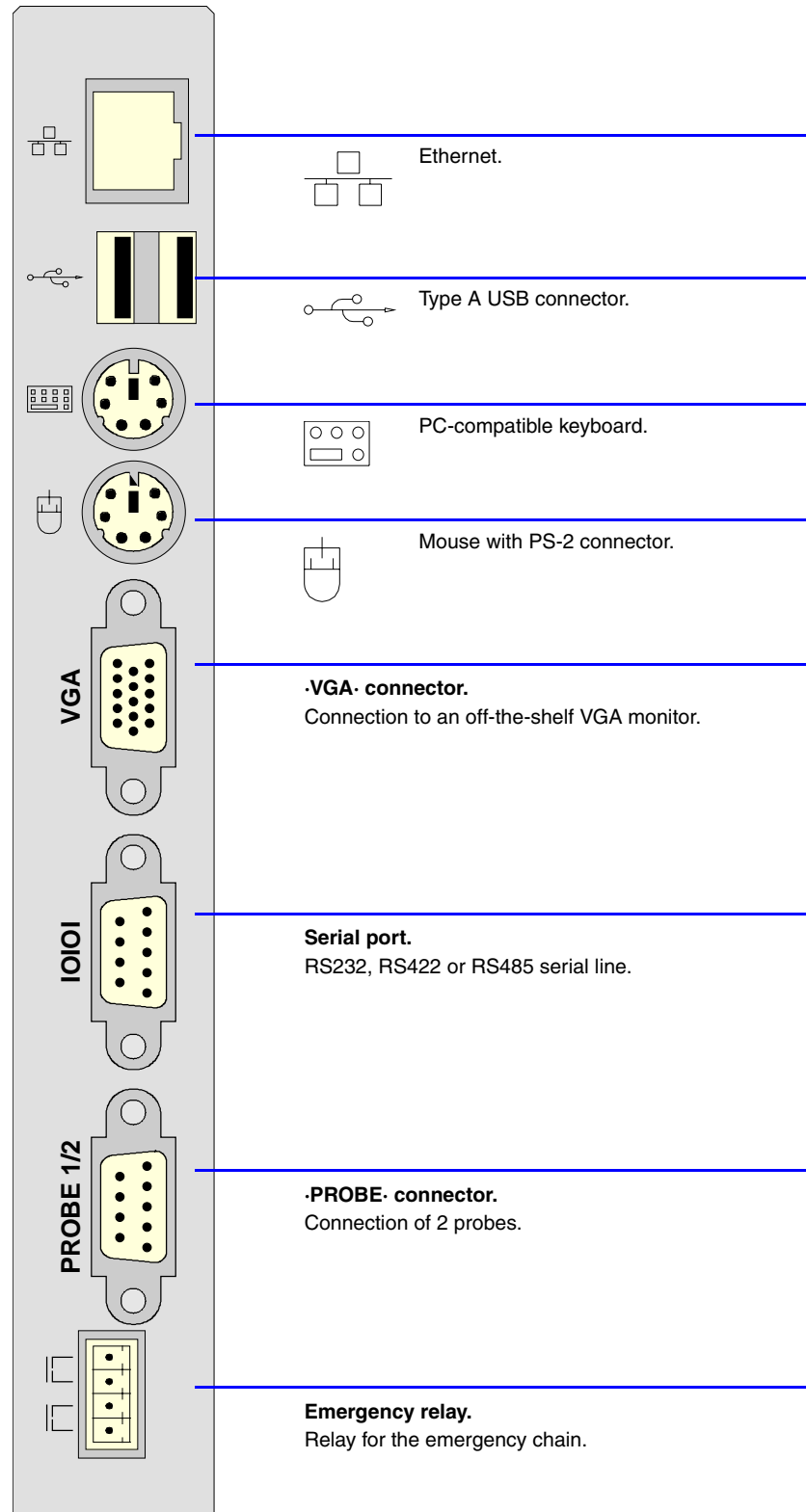

4.

CENTRAL UNITS ICU - MCU.

FAGOR

CNC 8070

(REF: 1007)

Ethernet.

8-pin RJ45 connector and 2 status LED's.

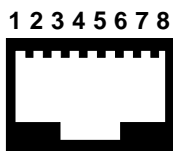

Pin.	Signal.
1	TX+ (transmit data).
2	TX- (transmit data).
3	RX+ (receive data).
4	- - -
5	- - -
6	RX- (receive data).
7	- - -
8	- - -

LED.	Meaning.
Green	The LED turns on when the central unit is connected to mains.
Yellow	The LED blinks when data is being transferred.

USB ports.

Type A USB double connector.



Pin.	Signal.
1	+ 5 V
2	DT -
3	DT +
4	GND



No USB devices must be used nor connected while executing a part program. Using USB devices may slow down the execution or cause some "RT-IT overflow" type error.

PC-compatible keyboard.

6-pin minidin female connector.

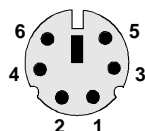

Pin.	Signal.
1	Keyboard data.
2	- - -
3	GND
4	+5 V
5	Keyboard clock.
6	- - -

Mouse with PS-2 connector.

6-pin minidin female connector.

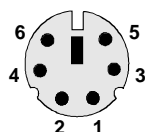

Pin.	Signal.
1	Mouse data.
2	- - -
3	GND
4	+5 V
5	Mouse clock.
6	- - -

·VGA· connector.

15-pin female SUB-D HD type connector.

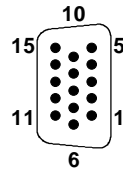

Pin.	Signal.	Pin.	Signal.
1	RED	9	---
2	GREEN	10	GND_SYNC
3	BLUE	11	---
4	---	12	---
5	GND	13	HSYNC
6	GND_RED	14	VSYNC
7	GND_GREEN	15	---
8	GND_BLUE		

·IOIOI· connector. Serial line.

9-pin male SUB-D type connector.

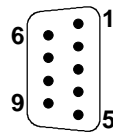

Pin.	RS232 signal.	RS422 signal.	RS485 signal.
1	DCD	---	---
2	RxD	LineTerm 120 Ω	LineTerm 120 Ω
3	TxD	/LineTerm 120 Ω	/LineTerm 120 Ω
4	DTR	---	---
5	GND	GND	GND
6	DSR	TxD	TxD RxD
7	RTS	/TxD	/TxD /RxD
8	CTS	RxD	TxD RxD
9	RI	/RxD	/TxD /RxD

At the CNC, the type of serial line is selected by means of the machine parameters (parameter RSTYPE).

·PROBE· connector. Probe connection.

9-pin female SUB-D type connector.

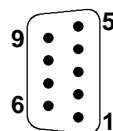

Pin.	Signal.	Description.
1	Chassis	Shield.
2	PRB1 +5 V	5 V output for probe 1.
3	PRB1 IN5V	5 V input of probe 1.
4	PRB1 IN24V	24 V input of probe 1.
5	PRB1 GND	0 V reference input of probe 1.
6	PRB2 +5 V	5 V output for probe 2.
7	PRB2 IN5V	5 V input of probe 2.
8	PRB2 IN24V	24 V input of probe 2.
9	PRB2 GND	0 V reference input of probe 2.

Relay for the emergency chain.

4-pin male Phoenix minicombicon contact (3.5 mm pitch).

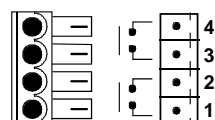

The relay contacts are normally open and they close when the CNC is powered up and running properly; they open again when the CNC is turned off or when an internal failure occurs.

These relays withstand up to 1 A at 24 V.

4.

CENTRAL UNITS ICU - MCU.



CNC 8070

(REF: 1007)

4.6.2 Expansion board.

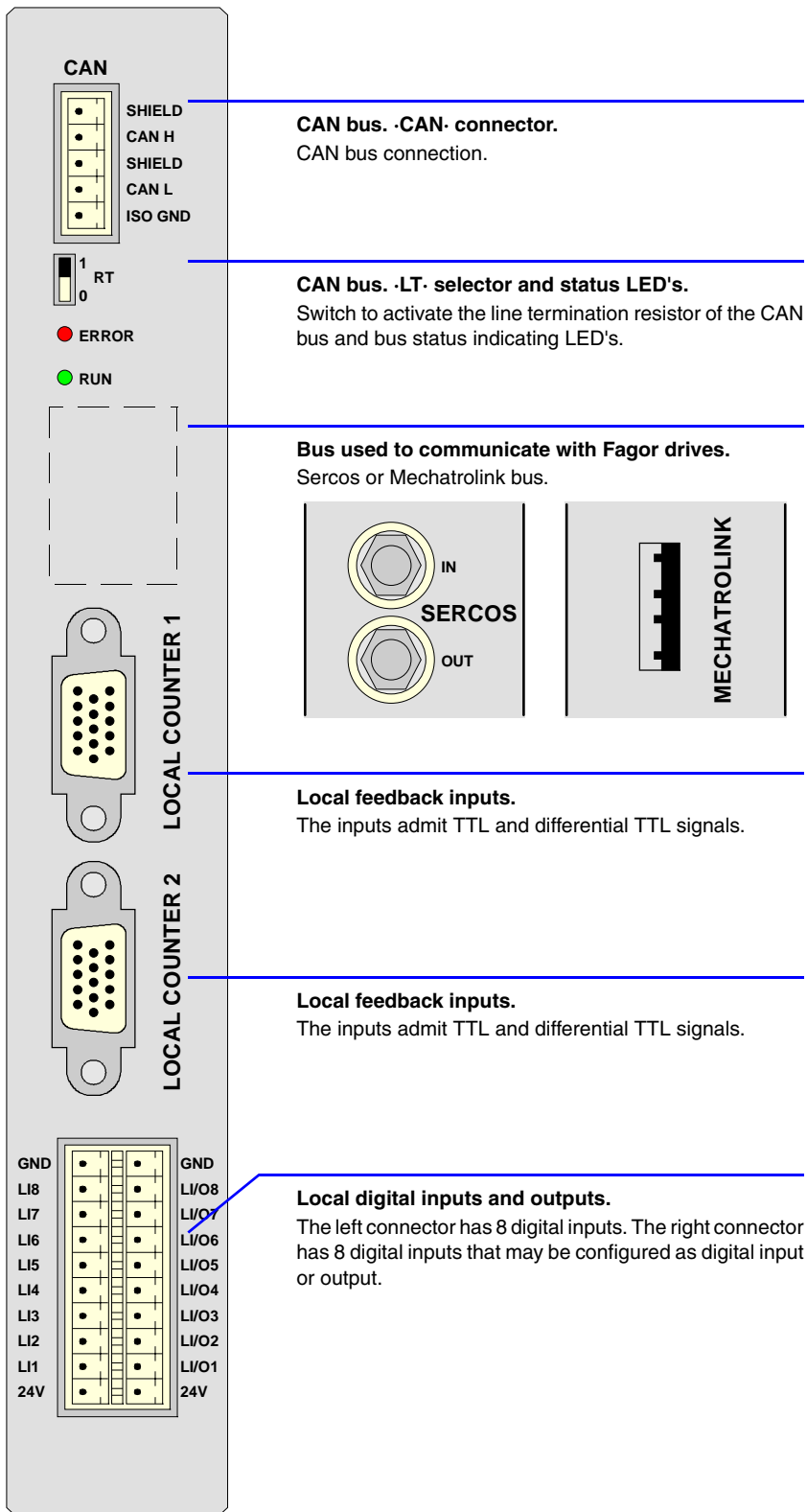

4.

CENTRAL UNITS ICU - MCU.



CNC 8070

(REF: 1007)

CAN bus. ·CAN· connector.

5-pin male Phoenix minicombicon contact (3.5 mm pitch).

SHIELD		5		Pin.	Signal.	Function.
CAN H		4		1	ISO GND	Ground / 0 V.
SHIELD		3		2	CAN L	(LOW) bus signal.
CAN L		2		3	SHIELD	CAN shield.
ISO GND		1		4	CAN H	(HIGH) bus signal.
				5	SHIELD	CAN shield.

For further information on how to configure the connection of the elements to the CAN bus, refer to chapter "[14 Bus CAN \(CANopen/CANopen protocols\)](#)." of this manual.

CAN bus. ·ST· selector.

Line terminating resistor. The ·LT· switch identifies which are the elements that occupy the ends of the CAN bus; i.e. the first and last physical element in the connection.

The switch position of the terminating elements must be "1" and that of the rest of the elements "0".

CAN bus. ·ERROR· LED.

Red LED. Its meaning depends on the blinking speed.

Type of blinking.	Meaning.
LED off.	The module works properly.
Blinking fast.	Module configuration stage.
Single blinking.	Warning. Poor transmission.
Double blinking.	There is no communication with the cpu.
LED on.	Error. Too many errors.

CAN bus. Led ·RUN·.

The LED is green. Its meaning depends on the blinking speed.

Type of blinking.	Meaning.
LED on.	The module works properly.
Single blinking.	Module stopped.
Blinking fast.	Module configuration stage.
Continuous blinking.	Start-up stage or error.

Bus used to communicate with Fagor drives. Sercos Bus.

·IN· & ·OUT· connectors Honeywell emitter and receiver.

	Signal.	Function.
IN	IN	Sercos signal receiver.
	OUT	Sercos signal emitter.

For further information on how to configure the connection of the elements to the Sercos bus, refer to chapter "[15 Sercos Bus.](#)" of this manual.

4.

CENTRAL UNITS ICU - MCU.



CNC 8070

(REF: 1007)

Bus used to communicate with Fagor drives. Mechatrolink bus.

A type USB connector with retainers.

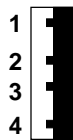

Pin.	Signal.
1	- - -
2	DT -
3	DT +
4	- - -

Local feedback inputs (TTL, differential TTL).

4 15-pin female SUB-D HD type connectors.

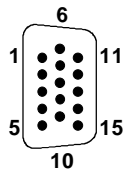

Pin.	Signal.	Description.
1	A	Feedback signals.
2	/ A	
3	B	
4	/ B	
5	I0	Reference signals.
6	/ I0	
7	AL	Feedback alarm.
8	/ AL	
9	+5 Vdc	Voltage supply for the feedback system.
10	- - -	
11	GND	0 V reference signal.
12	- - -	
13	- - -	
14	- - -	
15	Chassis(*)	Shield.

(*) Pin -15- is offered for compatibility. We recommend to connect the cable shield to the connector housing at both ends.

Local digital inputs (8 inputs). Local digital inputs or outputs (as configured).

3-pin two-level male Phoenix minicombicon contact (3.5 mm pitch).

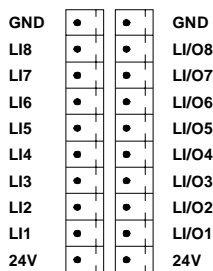

Signal	Function
GND	0 V reference signal.
LI1 - LI8	Digital inputs.
LI/O1 - LI/O8	Digital input or output (as configured).
24 V	24 V DC voltage supply.

Each LI/O pin of this connector may be configured as digital input or output by machine parameters. When a digital output is active, the connector must be connected to 24 V DC and GND.

Machine parameter NLOCOUT indicates the number of digital outputs available at the connector, the rest of the pins will act as digital inputs. Refer to the installation manual for further detail.

4.

CENTRAL UNITS ICU - MCU.



CNC 8070

(REF: 1007)

4.6.3 CPU board.

4.

CENTRAL UNITS ICU - MCU.

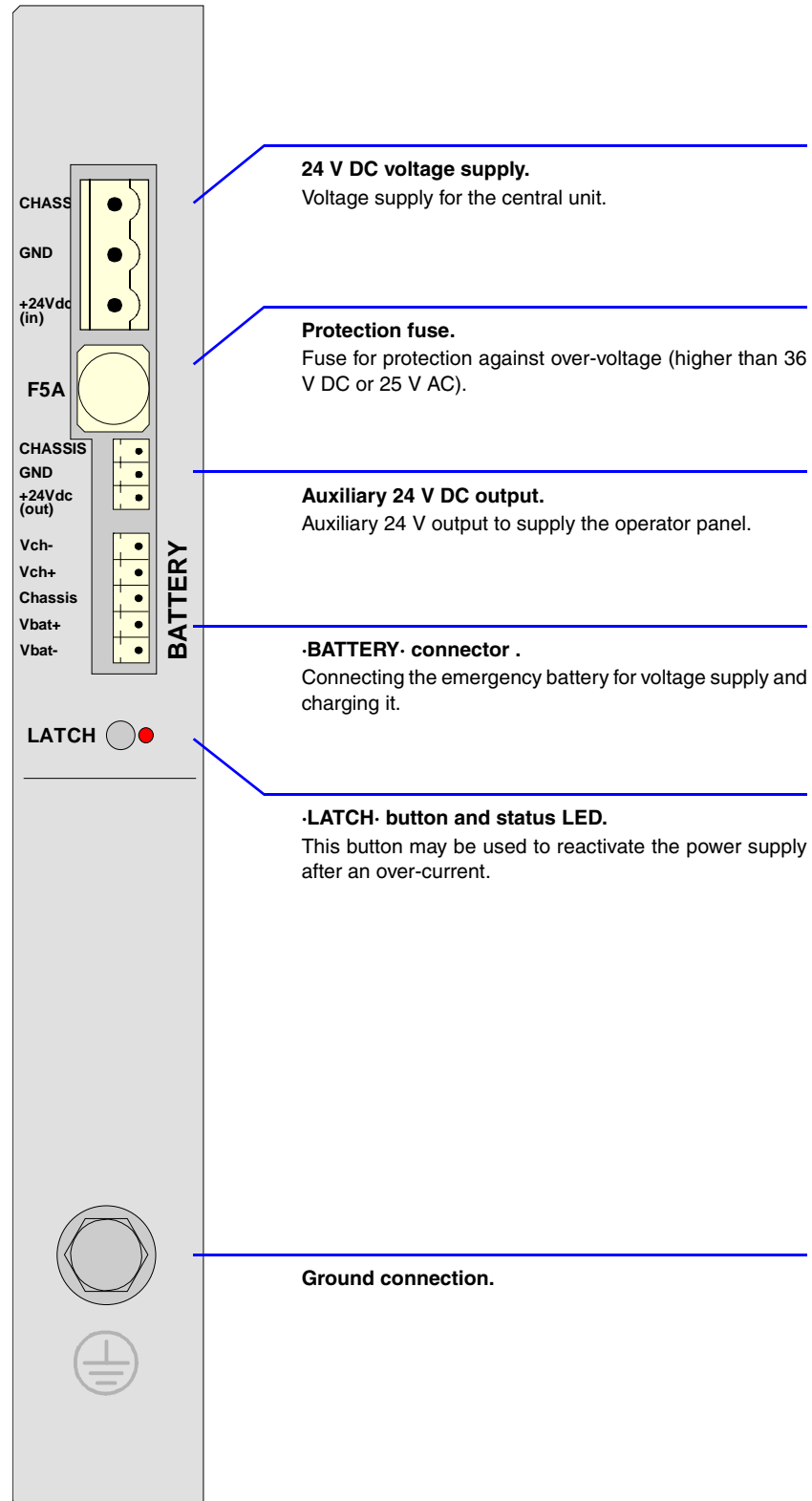

Power supply.

3-pin male Phoenix combicom contact (7.62 mm pitch).

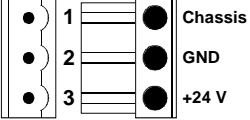
	Signal.	Function.
Chassis	Chassis	Shield.
GND	GND	Power supply.
+24 V	+24 V	Power supply.

Connector to power the central unit with universal 24 V DC. See "[4.7 Power connection.](#)" on page 64.

Protection fuse.

The module has a 5 A fuse that may be accessed from the outside to protect against over-voltage (greater than 36 V DC or 25 V AC).

Auxiliary 24 V output to supply the operator panel.

3-pin male Phoenix minicombicon contact (3.5 mm pitch).

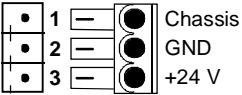
	Signal.	Function.
Chassis	Chassis	Shield.
GND	GND	Power supply.
+24 V	+24 V	Power supply.

This connector offers the possibility to supply voltage from the central unit to the operator panel. It is mainly oriented to those configurations where the operator panel is integrated into the monitor (LCD-10K) or close to it.

·BATTERY· connector . Battery voltage and charge.

5-pin male Phoenix minicombicon contact (3.5 mm pitch).

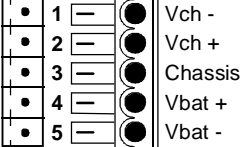
	Signal	Function
Vbat - Vbat +	Vbat - Vbat +	Central unit powered by the battery.
Chassis	Chassis	Shield.
Vch - Vch +	Vch - Vch +	Recharging the battery through the central unit.

This connector can also be used to connect an external battery that ensures the proper shut-down of the unit due to a power failure. The battery provides an autonomy of about 20 minutes when it is fully charged. See "[13.3 Operation of the emergency battery.](#)" on page 189.

·LATCH· button and status LED's.

When the red LED is on, it means that there is an over-current at the power supply and it is not running. The ·LATCH· button may be used to reactivate the power supply after an over-current. See "[4.7 Power connection.](#)" on page 64.

4.

CENTRAL UNITS ICU - MCU.

4.6.4 PCI expansion board (only for the MCU model).

4.

CENTRAL UNITS ICU - MCU.

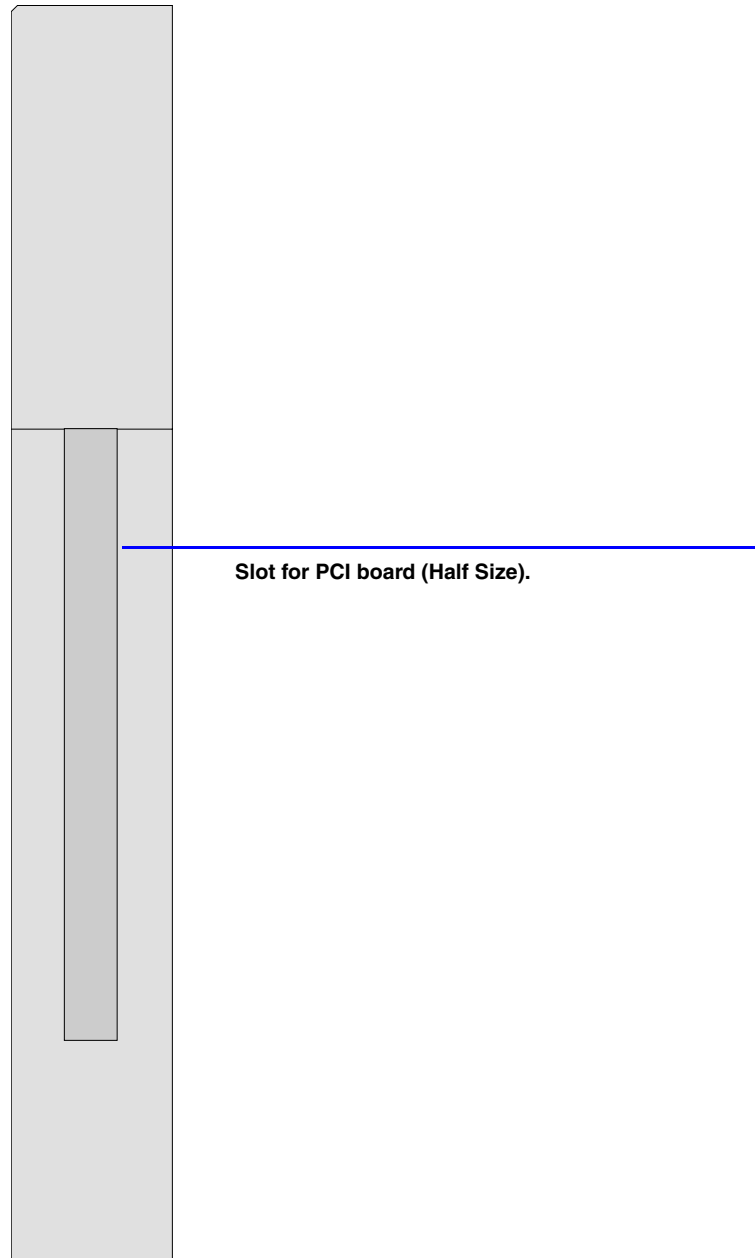
**Electrical characteristics of the PCI expansion.**

Characteristic.	Description.
Board size.	Half Size.
Connector.	PCI 5 V.
Interface.	PCI 32 bit 33 MHz
Power supply.	5 V / 2 A - 3.3 V / 2.5 A (Both may be used with a maximum consumption of 15 W).
V(I/O)	May be set for 5 V or 3.3 V using a jumper (by default, 5 V).

Jumper ·JP1·. Voltage selector V(I/O).

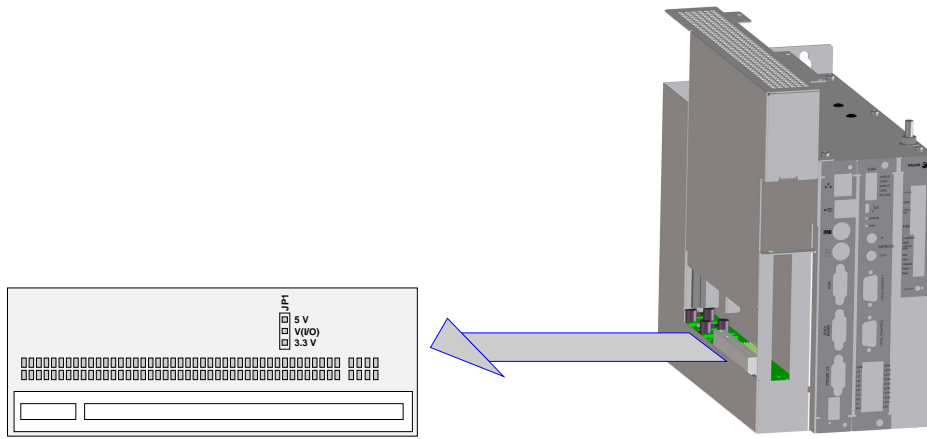

3-pin jumper for selecting the voltage of V(I/O).

·JP1·	Selected voltage.
	5 V
	3.3 V

4.

CENTRAL UNITS ICU - MCU.

4.6.5 Operator panel (only LCD-10K)

Connector ·X11·. Handwheel connection.

10-pin male Phoenix minicombicon contact (3.5 mm pitch).

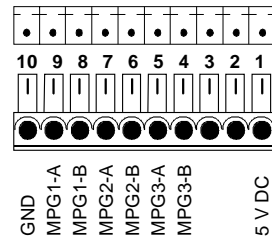

Pin	Signal	Function
1	+5 V	Power supply.
2	- - -	
3	- - -	
4	MPG3-B	B signal of the third handwheel.
5	MPG3-A	A signal of the third handwheel.
6	MPG2-B	B signal of the second handwheel.
7	MPG2-A	A signal of the second handwheel.
8	MPG1-B	B signal of the first handwheel.
9	MPG1-A	A signal of the first handwheel.
10	GND	Power supply.

The keyboard admits the connection of up to 3 handwheels (MPG1, MPG2 and MPG3) with A and B signals (5 V DC TTL). If the handwheel has an axis selector button, the button signal may be connected to a digital input and may be managed from the PLC using the -NEXTMPGAXIS-mark.

4.

CENTRAL UNITS ICU - MCU.

4.6.6 Digital inputs and outputs. Electrical characteristics.

Digital inputs.

All digital inputs are galvanically isolated through opto-couplers. All the digital inputs have the following characteristics:

Nominal voltage.	+24 V DC (between +18 V DC and +30 V DC).
High threshold "1".	Over +18 V DC.
Low threshold "0".	Under +9 V DC.
Typical consumption of each input.	5 mA.
Maximum consumption of each input.	7 mA.

Digital outputs.

All digital outputs are galvanically isolated through opto-couplers. All the digital outputs have the following characteristics:

Nominal voltage.	+24 V DC (between +18 V DC and +30 V DC).
Output voltage.	2 V less than the supply voltage.
Maximum output current.	500 mA per output.

4.

CENTRAL UNITS ICU - MCU.

4.6.7 Feedback inputs. Technical characteristics and connection.

The central unit has 2 feedback inputs, valid for TTL and differential TTL signals.

Technical characteristics of the feedback inputs.

Power consumption: +5 V 1 A (250 mA per axis)

Work levels for TTL signal.

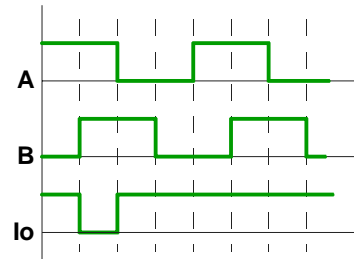

Maximum frequency:	400 kHz.
Maximum gap between flanks:	460 ns.
Phase shift:	$90^\circ \pm 20^\circ$.
High threshold (logic level "1") VIH:	$1.25 \text{ V} < V_{IH} < 7 \text{ V}$.
Umbral bajo (nivel lógico "0") VIL:	$-7 \text{ V} < V_{IL} < 1 \text{ V}$.
Maximum voltage:	$\pm 7 \text{ V}$.
Hysteresis:	0,25 V.
Maximum differential input current:	3 mA.

Work levels for differential TTL signal.

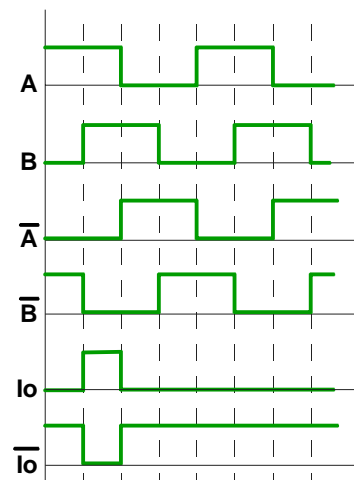

Maximum frequency:	1000 kHz.
Maximum gap between flanks:	460 ns.
Phase shift:	$90^\circ \pm 20^\circ$.
Maximum voltage in common mode:	$\pm 7 \text{ V}$.
Maximum voltage in differential mode:	$\pm 6 \text{ V}$.
Hysteresis:	0.2 V.
Maximum differential input current:	3 mA.

4.

CENTRAL UNITS ICU - MCU.

Feedback cable characteristics.



Fagor Automation offers a wide range of cables and extension cables to connect the feedback systems to the CNC. Refer to our catalog for further information.

The cable used must have overall shield; the rest of the characteristics of the cable, as well as its length, will depend on the type of feedback device used. Refer to our catalog.

The shield of the cable being used must be connected to the connector housing at both ends. The unshielded portion of the wires of an unshielded cable cannot be longer than 75 mm.

We recommend to run the feedback cables as far away as possible from the power cables of the machine.

4.

CENTRAL UNITS ICU - MCU.

4.7 Power connection.

Voltage supply for the central unit.

The central unit is powered by an external DC power supply; use a 24 V DC $\pm 10\%$ and 3.5 A. power supply.



Consult the electrical characteristics of the central unit before connecting the power supply. See "4.1 Technical characteristics." on page 39.

It is also possible to connect an external battery that ensures the proper operation of the unit under AC power outages. See chapter "[13 Emergency battery](#)".

Over-current at the power supply.

An over-current activates the safety device inside the power supply turns on the external red LED. The power supply will not be operative while the LED is on. There are two ways to reactivate the power supply after an over-current.

- Unplug the power supply from mains and wait for about 30 seconds until the red light turns off.
- Unplug the power supply and press the **·LATCH·** button. The red LED will turn off indicating that the power supply is ready.

If after reactivating the power supply, the LED turns back on, call the Technical Service Department.

4.

CENTRAL UNITS ICU - MCU.

4.8 housing for the compact flash and battery-powered RAM memory.

The housing for the compact flash and the battery of the non-volatile RAM memory is located on top of the central unit.

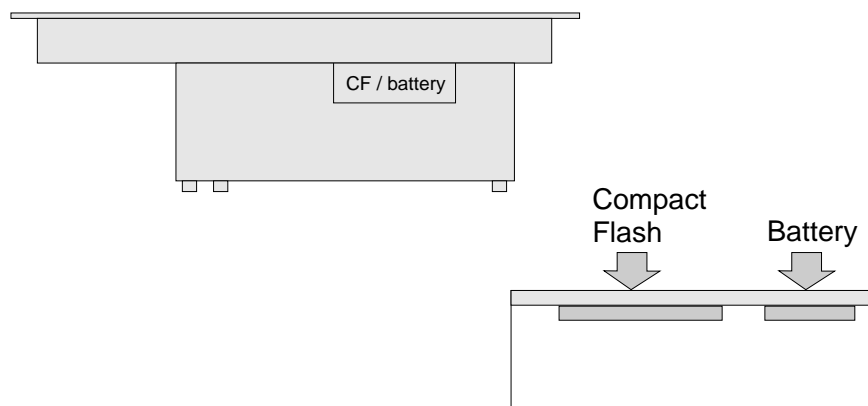

How to replace the battery of the non-volatile RAM memory.

The non-volatile RAM memory uses a 3 V CR2450 battery.

- 1 Turn the CNC off and unplug it.
- 2 Get into the enclosure by removing the protective cover.
- 3 Remove the battery by pulling it up smoothly.
- 4 Insert the new battery maintaining the same polarity. The battery must get into its housing easily, without having to force it.
- 5 Put the protective cover back on.
- 6 Plug the unit in.

While the battery is being replaced, the CNC keeps the data of the non-volatile RAM memory.

4.

CENTRAL UNITS ICU - MCU.

4.9 Insert the board into the PCI expansion (only in MCU models).

Precaution when handling the boards.

Handle the boards very carefully to avoid damaging them or their elements, contacts or conducting lines. Place the modules in the correct position. Do not use a sharp-pointed object (like a screwdriver) as a lever.



This symbol identifies the cards as ESD components (sensitive to electrostatic discharges). Bear in mind the following considerations when handling boards with ESD:

- Before handling the ESD boards, discharge their static electricity (for example by touching an object that is connected to ground).
- The units and tools being used must be free of any static charge-
- Turn the power supply of the unit off before inserting or removing the board.
- Hold the ESD board only at its corners or edges; do not touch its components, contacts or conducting lines.

Voltage for the pins V(I/O).

The supply voltage for the V(I/O) pins of the connector may be set for 5 V or 3.3 V (by default, 5 V). See ["4.6.4 PCI expansion board \(only for the MCU model\)."](#) on page 58.

Mounting the boards.



Do not open the unit or handle the internal boards while the unit is connected to power. Before opening the unit, make sure that the unit is unplugged from the power outlet.

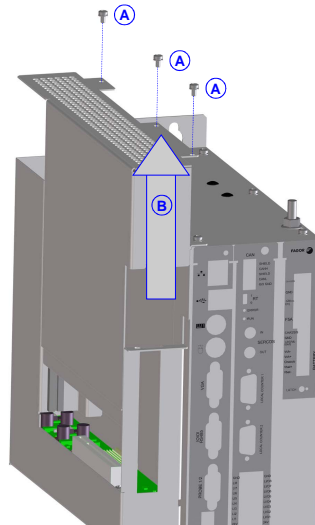

Remove the three mounting screws (A) of the lid, located on top and slide the lid in the direction of the arrow (B).

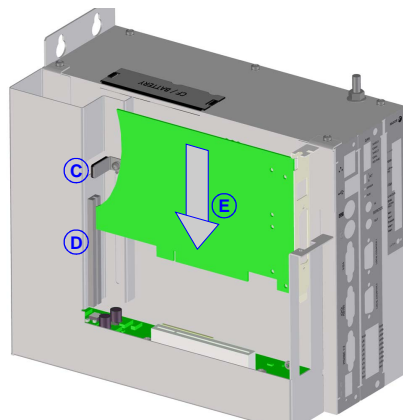

Loosen the locking angle bracket (C) and turn it to allow the board to slide in. Insert the board in the slot (D) and push it in the direction of the arrow (E) all the way in.

4.

CENTRAL UNITS ICU - MCU.



CNC 8070

(REF: 1007)

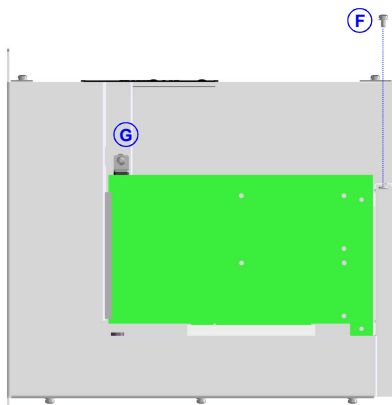

Secure the board with the screw (F). Turn and fasten the locking angle bracket (G) to hold the board.

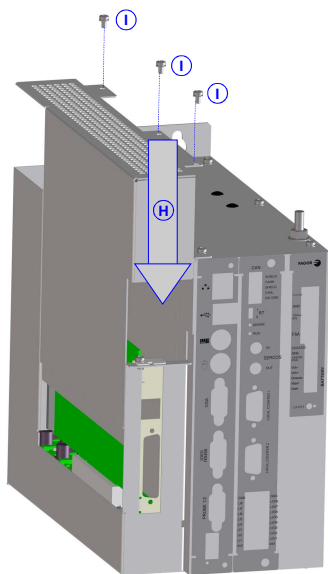

Put and slide the lid in the direction of the arrow (H). Fasten the three mounting screws (I) of the lid.

4.

CENTRAL UNITS ICU - MCU.

4.10 RS232 serial line connection.

Pinout of the central unit connector.

9-pin male SUB-D type connector.

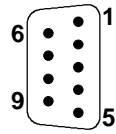

Pin.	Signal.	Description.
1	DCD	Carrier detect.
2	RxD	Receive data.
3	TxD	Send data.
4	DTR	Data terminal ready.
5	GND	Ground connection.
6	DSR	Data set ready.
7	RTS	Request to send.
8	CTS	Clear to send.
9	RI	Ring indicator.

Cable characteristics.

Twisted-pair shielded cable should be used to minimize interference between cables, thus preventing poor communication in long lengths.

Characteristic.	
Type.	Shielded. Twisted-pair, with a minimum wire section of 0.14 mm ² .
Capacitance.	164 pF/m (50 pF/ft).
Maximum length.	At a baudrate of 19200 Bd, 15 m (50 ft) or a length equivalent to a capacitance of 2500 pF.

Node connection.

Module interconnection.

The cable shield must be connected to the connector at both ends. It is recommended to reference all the control and data signals to the same point (pin 5 GND), thus avoiding reference points with different voltages because there could be voltage differences in long lengths between the two ends of the cable.

- Simplified connection.

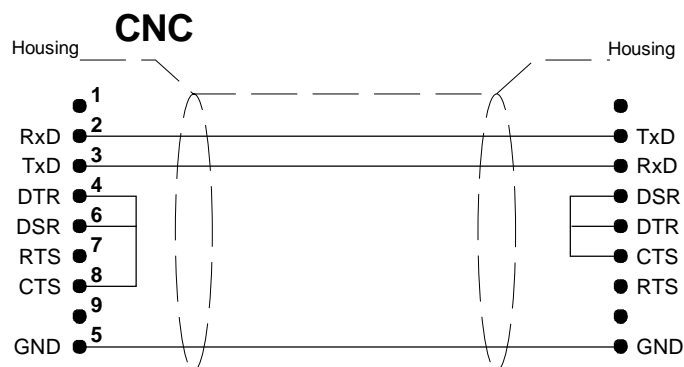

CNC 8070

(REF: 1007)

- Full connection.

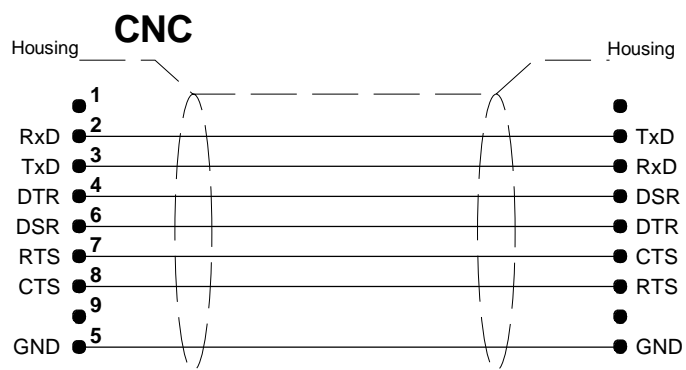

4.

CENTRAL UNITS ICU - MCU.

4.11 RS422 serial line connection.

Pinout of the central unit connector.

9-pin male SUB-D type connector.

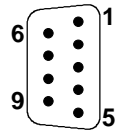

Pin.	Signal.	Description.
1	---	---
2	LineTerm	120Ω line terminating resistor.
3	LineTerm	120Ω line terminating resistor.
4	---	---
5	GND	Ground connection.
6	TxD	Send data.
7	/TxD	Send data.
8	RxD	Receive data.
9	/RxD	Receive data.

The reserved pins must NOT be used in any case.

Cable characteristics.

Twisted-pair shielded cable should be used to minimize interference between cables, thus preventing poor communication in long lengths.

Characteristic.	
Type.	Shielded. Twisted-pair, with a minimum wire section of 0.20 mm ² (24 AWG).
Impedance.	120Ω.
Maximum length.	1200 m (3937 ft).

Node connection.

Line terminating resistor.

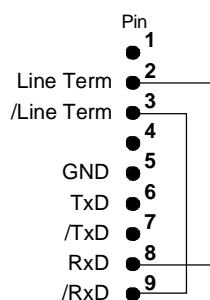

All the elements of the bus must have the line terminating resistor activated. The central unit has the resistor inside at pins 2 and 3; to activate it, jumper pin 2 with pin 8 and pin 3 with 9.

Module interconnection.

The cable shield must be connected to the connector at both ends. It is recommended to reference all the control and data signals to the same point (pin 5 GND), thus avoiding reference points with different voltages because there could be voltage differences in long lengths between the two ends of the cable.

4.

CENTRAL UNITS ICU - MCU.



CNC 8070

(REF: 1007)

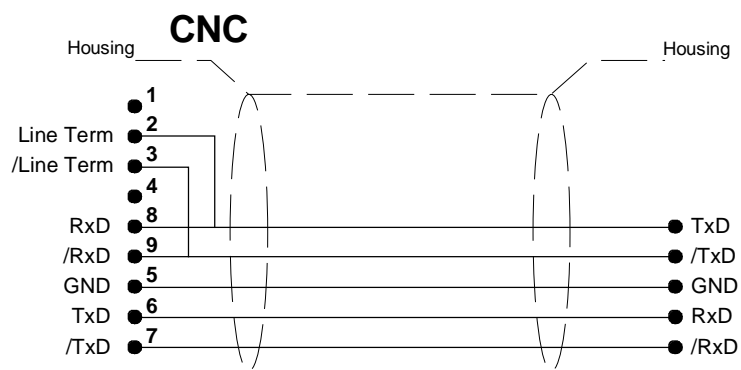

4.

CENTRAL UNITS ICU - MCU.



CNC 8070

(REF: 1007)

4.12 RS485 serial line connection.

Pinout of the central unit connector.

9-pin male SUB-D type connector.

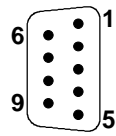

Pin.	Signal.	Description.
1	---	---
2	LineTerm	120Ω line terminating resistor.
3	LineTerm	120Ω line terminating resistor.
4	---	---
5	GND	Ground connection.
6	TxD RxD	Data send/receive.
7	/TxD RxD	Data send/receive.
8	TxD RxD	Data send/receive.
9	/TxD RxD	Data send/receive.

Pins 6-8 and 7-9 are internally jumpered, thus either one can be used in the connection. The reserved pins must NOT be used in any case.

Cable characteristics.

Twisted-pair shielded cable should be used to minimize interference between cables, thus preventing poor communication in long lengths.

Characteristic.	
Type.	Shielded. Twisted-pair, with a minimum wire section of 0.20 mm ² (24 AWG).
Impedance.	120Ω.
Maximum length.	1200 m (3937 ft).

Node connection.

Line terminating resistor.

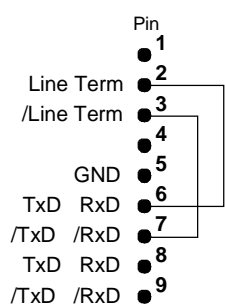

The elements located at the ends of the bus must have the line terminating resistor activated. The central unit has the resistor inside at pins 2 and 3; to activate it, jumper pin 2 with one of the pins 6/8 and pin 3 with one of the pins 7/9.

Module interconnection.

The cable shield must be connected to the connector at both ends. It is recommended to reference all the control and data signals to the same point (pin 5 GND), thus avoiding reference points with different voltages because there could be voltage differences in long lengths between the two ends of the cable.

4.

CENTRAL UNITS ICU - MCU.



CNC 8070

(REF: 1007)

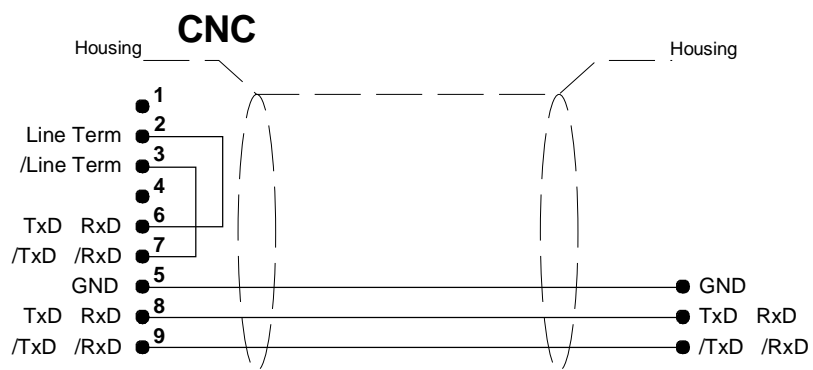

4.

CENTRAL UNITS ICU - MCU.

4.13 Probe connection.

The CNC has two probe inputs, 5 V and 24 V. The following diagrams use the first probe input (pins -2- to -5-); to use the second input, use pins -6- to -9-.

All the shields of the cables must be connected to ground only at the CNC through pin -1- of the connector, leaving the other one free. The unshielded portion of the wires of a shielded cable cannot be longer than 75 mm.

Probe whose output has a normally open contact. Connection to +5 V.

The connection acts upon the up flank (positive pulse) of the probe signal.

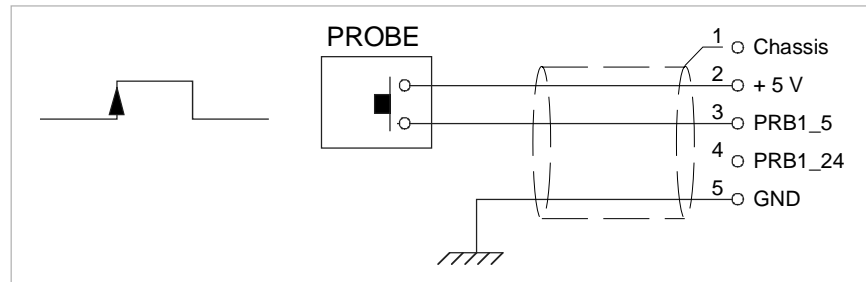

Probe whose output has a normally open contact. Connection to +24 V.

The connection acts upon the up flank (positive pulse) of the probe signal.

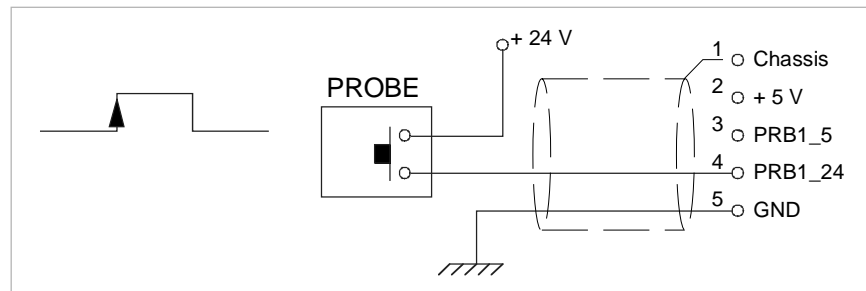

Probe whose output has a normally closed contact. Connection to +5 V.

The connection acts upon the up flank (positive pulse) of the probe signal.

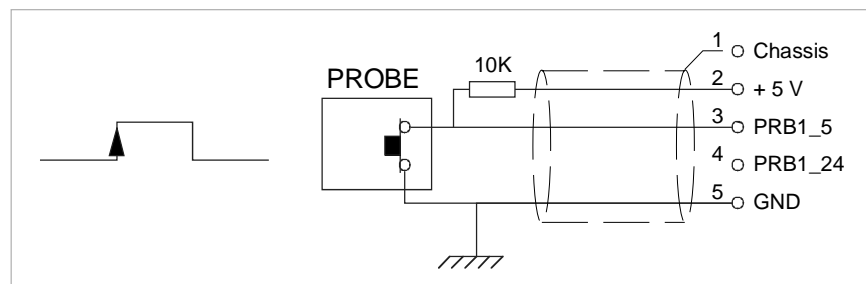

Probe whose output has a normally closed contact. Connection to +24 V.

The connection acts upon the up flank (positive pulse) of the probe signal.

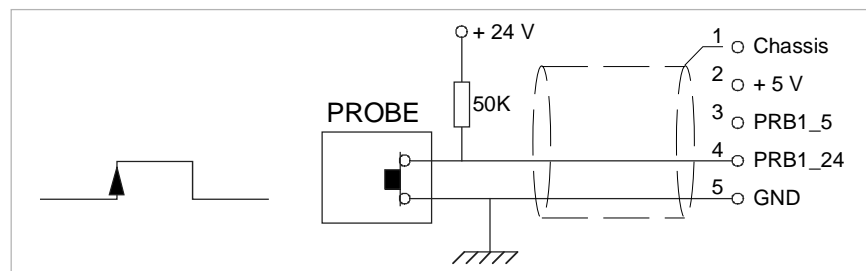

4.

CENTRAL UNITS ICU - MCU.

Interface with an open-collector output. Connection to +5 V.

The connection acts upon the down flank (negative pulse) of the probe signal.

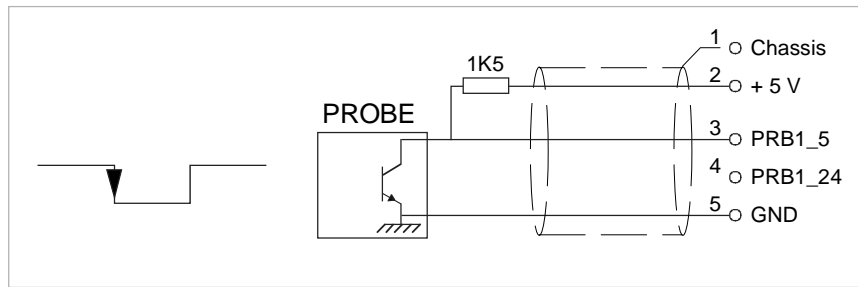

Interface with an open-collector output. Connection to +24 V.

The connection acts upon the down flank (negative pulse) of the probe signal.

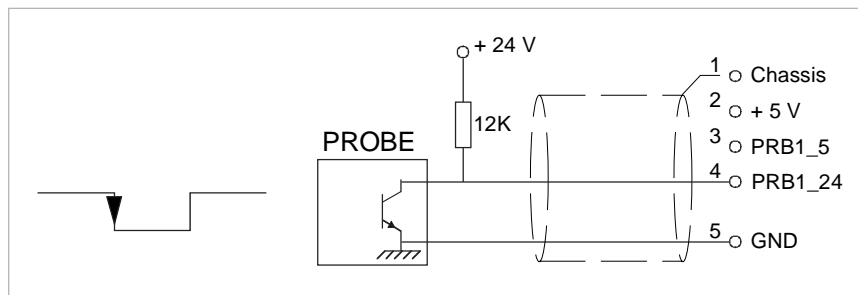

Interface with a PUSH-PULL output. Connection to +5 V.

Depending on the interface being used, the connection acts upon the up flank or down flank of the probe signal.

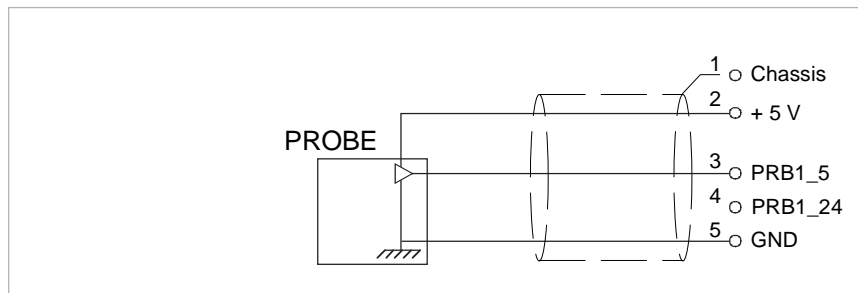

Interface with a PUSH-PULL output. Connection to +24 V.

Depending on the interface being used, the connection acts upon the up flank or down flank of the probe signal.

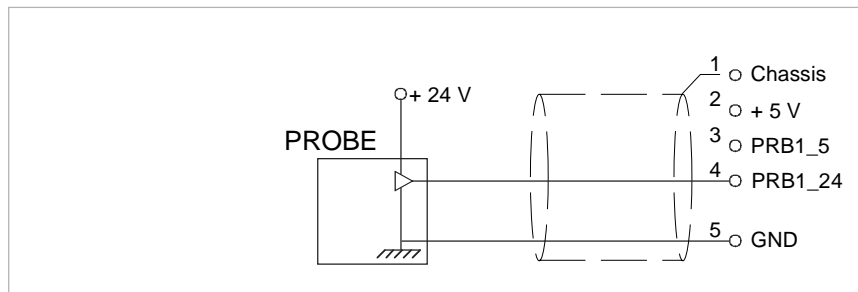

4.

CENTRAL UNITS ICU - MCU.

4.14 Connection to an Ethernet network.

With Ethernet connection, the CNC may be configured as another node in the local network, thus being able to communicate with other CNC's or PC for transferring files, run telediagnosis, etc. With Ethernet connection, it is also possible to connect directly (point to point) with another CNC or PC.

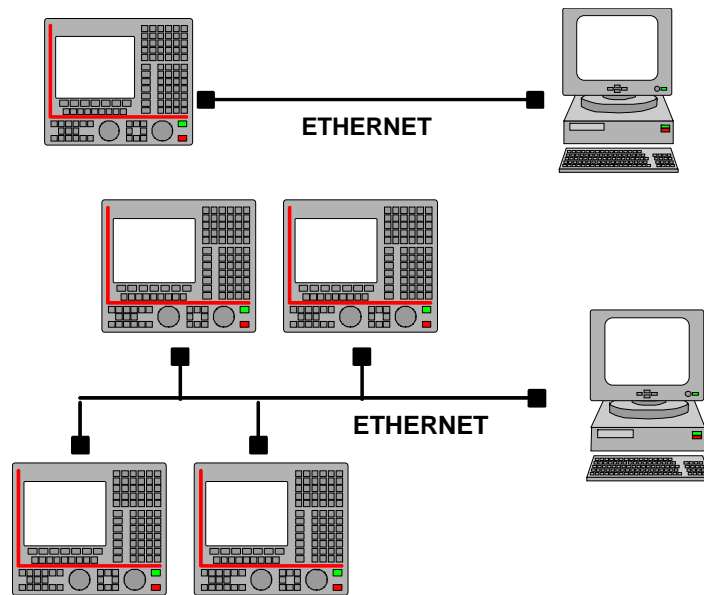

Baudrate.

The CNC permits a connection at 10 MHz or 100 MHz. By default, the CNC is configured for a 10 MHz connection.

Use a cable having the recommended characteristics to ensure a transmission at 100 MHz. Even so, since the transmission speed depends on the configuration of the network (number of nodes, their configuration, etc.) a 100 MHz transmission might not be stable. In these cases, we recommend to connect at 10 MHz,

Element connection.

Use a standard shielded 10BASE-T cable Use a crossed cable to connect directly (point to point) to another CNC or PC. In either case, the maximum cable length is 100 meters (328 ft).

In order to ensure proper performance, the connection cable must be inserted all the way into the connectors so they're latched. This ensures that the cable is properly latched and does not come off due to vibration.

Status indicator LED's.

The Ethernet connector has two status indicator LED's.

Green LED.	LED on when the CNC is connected to mains.
Yellow LED.	The LED blinks when data is being transferred.

Cable characteristics.

Use a specific Ethernet cable.

Type.	Twisted pair. Shielded.
Impedance.	Cat.5 (100Ω - 120Ω) or greater.

4.

CENTRAL UNITS ICU - MCU.



CNC 8070

(REF: 1007)

5 LCD-15SVGA. PASSIVE MONITOR " LCD15-SVGA".

The passive screen may be used to display the video signal coming from the ·VGA· connector of the central unit and also interact with the central unit using softkeys. This screen may be the only one connected to the central unit (for example, with the central unit MCU) or it may be a second monitor (for example, with the central unit ICU). When the screen is used as a second monitor, both monitors show the same video signal.

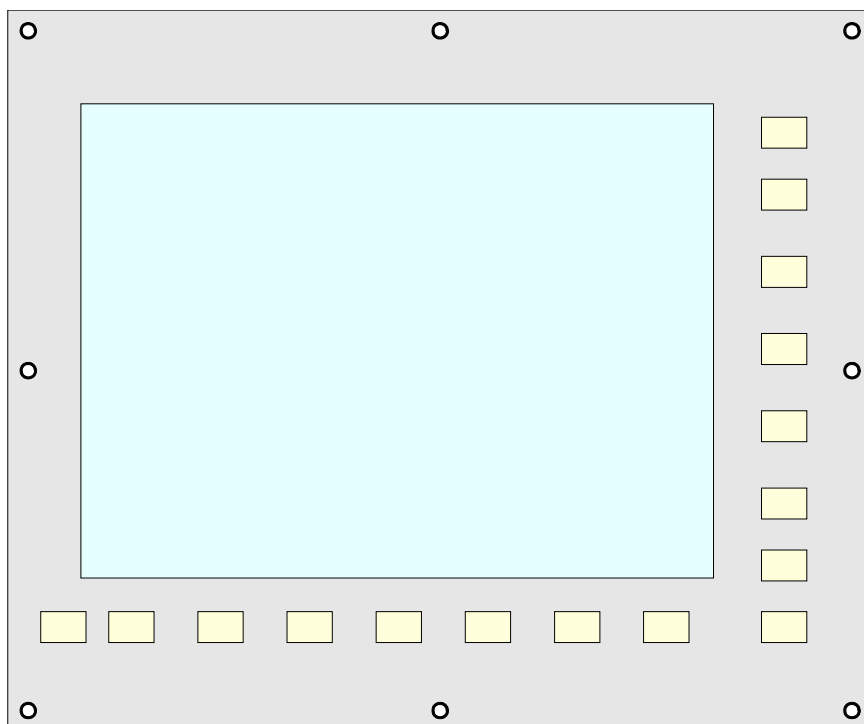

General characteristics.	
Power supply.	24 Vdc universal power supply.
Connection.	Connect the screen to the ·VGA· output of the central unit and the softkeys to the keyboard.
Degree of protection.	The face plate meets the IP 54 protection standard and the rear the IP 2X standard.

5.

LCD-15SVGA. PASSIVE MONITOR " LCD15-SVGA".

5.1 Possible configurations.

The passive screen and the MCU central unit.

The passive screen permits having a work station consisting of the screen itself and an operator panel OP-PANEL-H/E. Connect the screen to the VGA output of the central unit and the operator panel to the CAN bus of the system. Also connect the softkeys of the central unit to the keyboard.

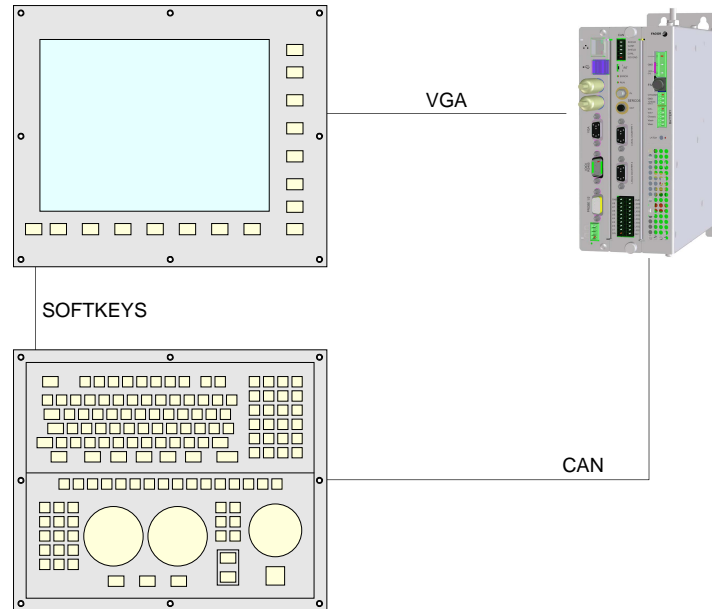

The passive screen and the ICU central unit.

The passive screen permits having a second work station consisting of the screen itself and an operator panel OP-PANEL-H/E. Connect the screen to the VGA output of the central unit and the operator panel to the CAN bus of the system. Also connect the softkeys of the central unit to the keyboard.

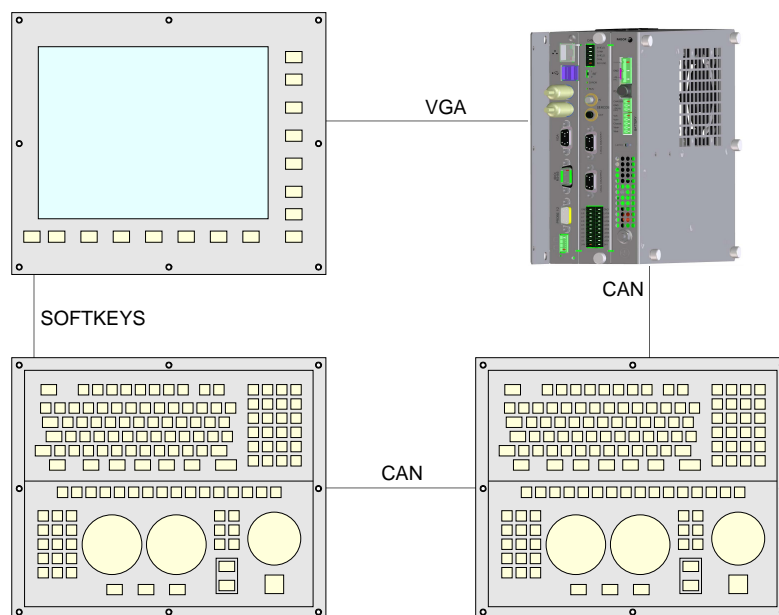

5.

LCD-15SVGA. PASSIVE MONITOR " LCD15-SVGA ".

FAGOR

CNC 8070

(REF: 1007)

5.2 Technical characteristics.

Electrical characteristics.

The unit has an internal power supply with the following characteristics.

Electrical characteristics.	
Input voltage.	24 V DC \pm 10% and 2 A.
Efficiency.	Greater than 80%.
Insulation.	1000 V DC; 1 minute.

Unit protections.

- Internal 5 A fuse.
- Protection against over-voltage peaks (higher than 36 V D) and reverse voltage. It is also protected against reverse connection of the power supply, preventing it from starting up.
- Protection against over-current.

Vibrations.

- Sweep sine trial with a frequency step of 1 octave/minute (\pm 10%) and 10 sweeps long.
 - 9 Hz \geq f \geq 5 Hz Constant movement with an amplitude of 3,5 mm.
 - 150 Hz \geq f \geq 9 Hz Constant 1g acceleration.

Packaging and resistance to falls.

- Packaging: Meets the EN 60068-2-32 regulation.
- Free fall packaged according to Fagor regulations (1 meter):

Ambient conditions.

- Relative humidity: 10-95% without condensation.
- Work temperature: 0-45 °C with an average lower than 35 °C.
- Storage temperature: Between -40 °C (77 °F) and +70 °C (158 °F).
- Maximum work altitude: Meets the IEC 1131-2 standard.

Degree of protection.

- Front panel: It meets the protection standard IP 54.
- Rear panel: It meets the protection standard IP 2X.



Do not get into the inside of the unit. This unit MUST NOT be opened by unauthorized personnel. Only personnel authorized by Fagor Automation may manipulate the inside of this unit.

5.

LCD-15SVGA. PASSIVE MONITOR " LCD15-SVGA " .

FAGOR

CNC 8070

(REF: 1007)

5.3 Hardware dimensions.

5.

LCD-15SVGA. PASSIVE MONITOR " LCD15-SVGA ".

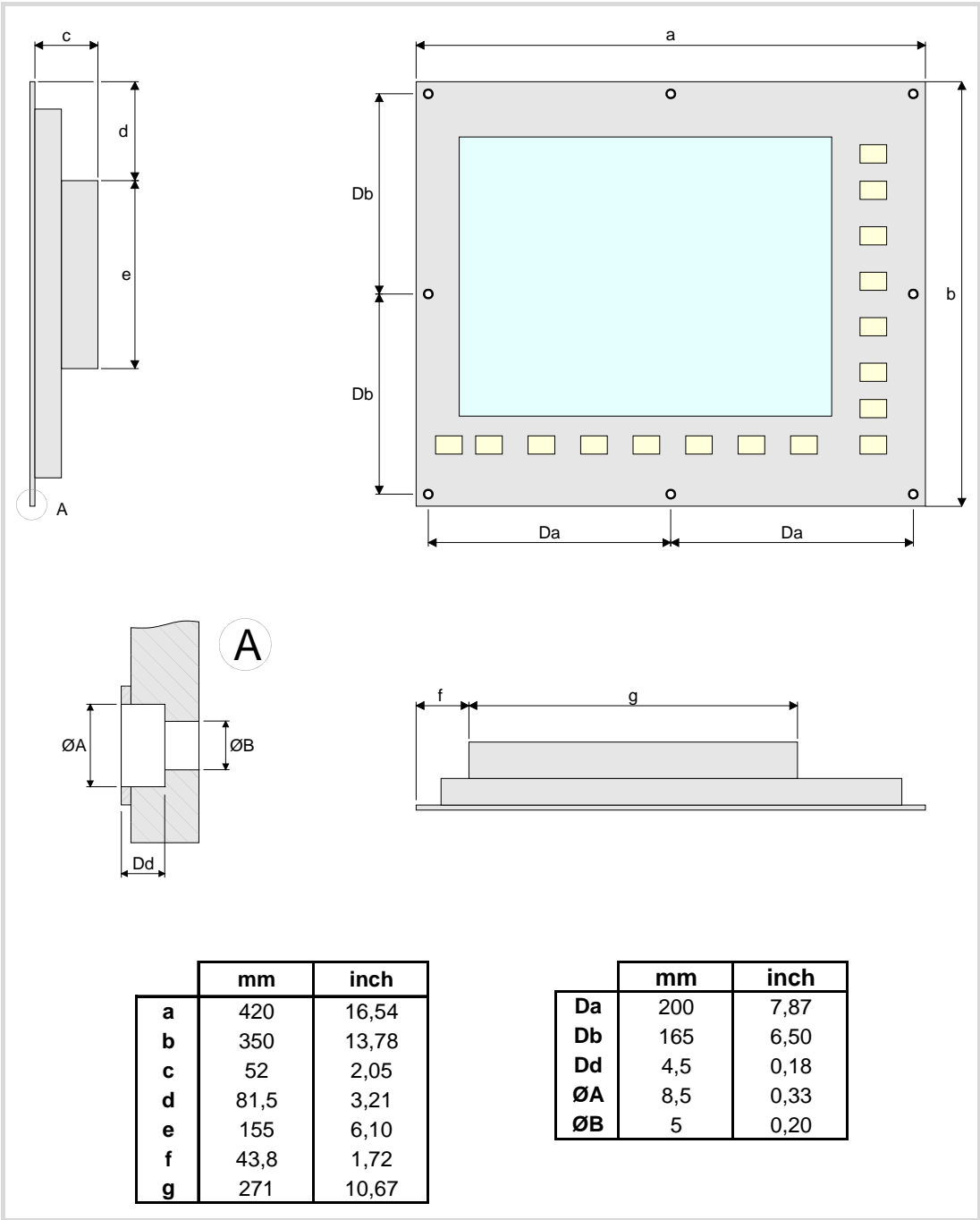

CNC 8070

(REF: 1007)

5.4 Dimensions and characteristics of the enclosure.

The enclosure must meet the following requirements.

- Respect the minimum distances recommended between the enclosure walls and the hardware to allow air flow. This space makes it also possible to bend the cables for the hardware connection with the recommended bending radius.
- Keep the enclosure clean. If the enclosure has ventilation holes, anti-dust filters should be installed in all of them.

Minimum gaps recommended between the enclosure walls and the hardware.

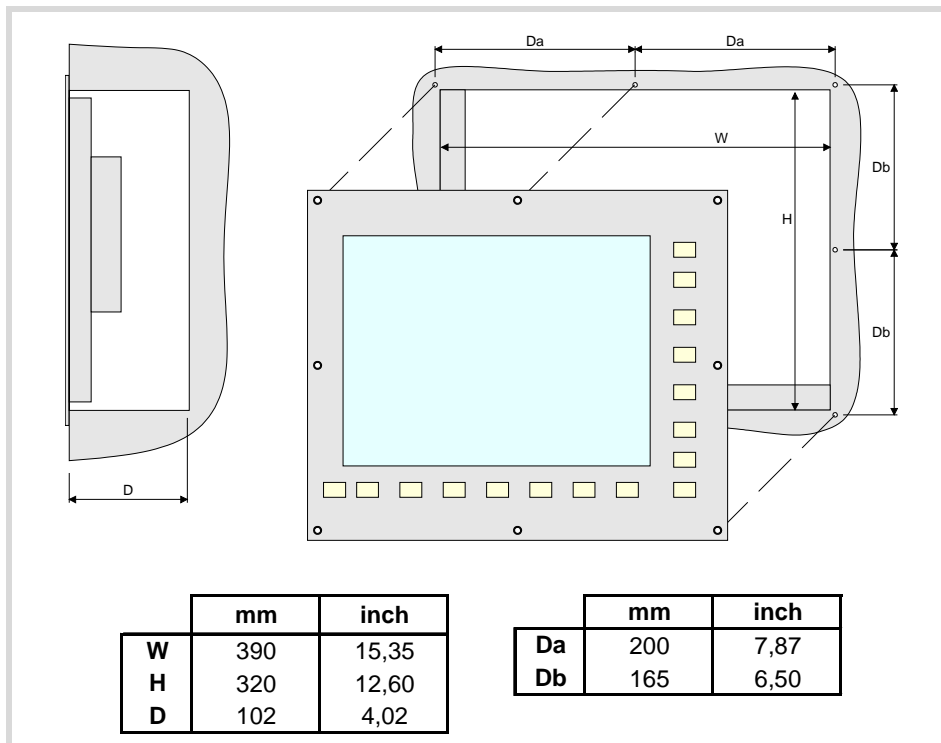

Securing the module.

The module must be installed in a proper enclosure that may be located on the machine or on an external support. To insert the unit into the enclosure, it must have a big enough hole to allow to insert it easily, without obstacles and without forcing the unit.

Once the unit has been inserted into the enclosure, secure it from the outside with M4 or UNC8 screws. To properly secure it, use the mounting holes on the front panel of the unit.

5.

LCD-15SVGA. PASSIVE MONITOR " LCD15-SVGA " .

FAGOR 

CNC 8070

(REF: 1007)

5.5 Elements (connectors).

·SOFTKEYS· connector .

Connection of the softkeys of the monitor to the keyboard. Maximum cable length is 1 meter.

Power supply.

3-pin male Phoenix combicom contact (7.62 mm pitch).

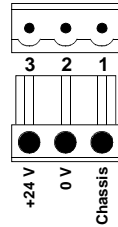

Signal.	Function.
Chassis	Shield.
0 V	Power supply.
+24 V	Power supply.

Universal power supply for 24 VAC and 1.5 A.

·VGA· connector.

15-pin female SUB-D HD type connector.

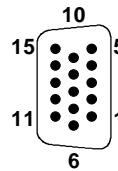

Pin.	Signal.	Pin.	Signal.
1	RED	9	---
2	GREEN	10	GND_SYNC
3	BLUE	11	---
4	---	12	---
5	GND	13	HSYNC
6	GND_RED	14	VSYNC
7	GND_GREEN	15	---
8	GND_BLUE		

LCD-15SVGA. PASSIVE MONITOR " LCD15-SVGA ".

5.6 Overall connection.

Power supply.

The passive screen is powered by an external DC power supply; use a 24 V DC $\pm 10\%$ and 2 A. power supply.

VGA video signal.

Use the VGA output of the central unit. It is a parallel connection, 1 to 1, 2 to 2, etc. The cable shield must be connected to the connector at both ends.

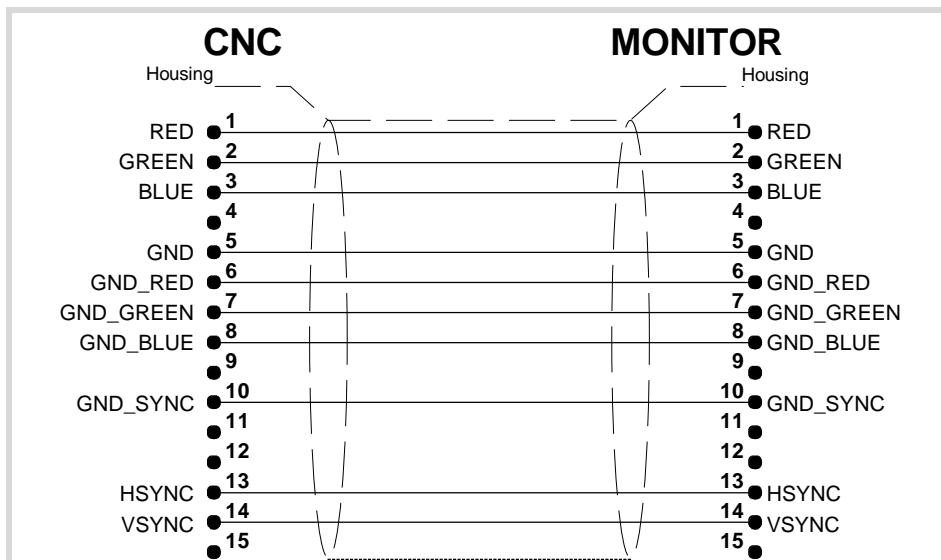

Cable characteristics.

Use specific VGA cable.

VGA cable.	
Flexibility.	Normal.
Type.	Shielded.
Impedance.	75Ω.
Maximum length.	30 m.



Fagor Automation supplies the necessary cable for the VGA connection. The cable is valid for static installations such as cable carrying chains. For further information, refer to the Ordering Handbook.

5.

LCD-15SVGA. PASSIVE MONITOR " LCD15-SVGA".

6 OP-PANEL-H/E MODULE. KEYBOARD AND OPERATOR PANEL.

Set of alpha-numeric QWERTY keyboard with integrated operator panel. The operator panel has either an emergency button (E-stop) or a handwheel.

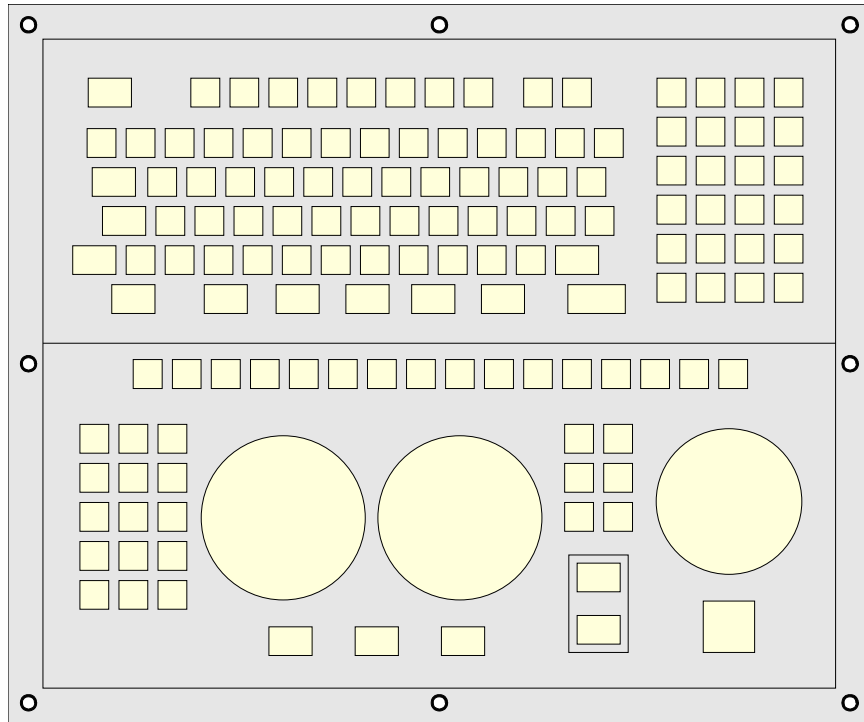

General characteristics.	
Power supply.	24 Vdc universal power supply.
Connection.	Connection to the central unit through CAN bus.
Electronic handwheels.	Possibility to connect up to three handwheels with A and B signals (5 V DC TTL).
Degree of protection.	It meets the protection standard IP 54.



The machine manufacturer must comply with the EN 60204-1 (IEC-204-1) regulation regarding electrical shocks in case of defective input/output pins with external power supply when not plugging the connector before turning the power supply on.

6.1 Hardware dimensions.

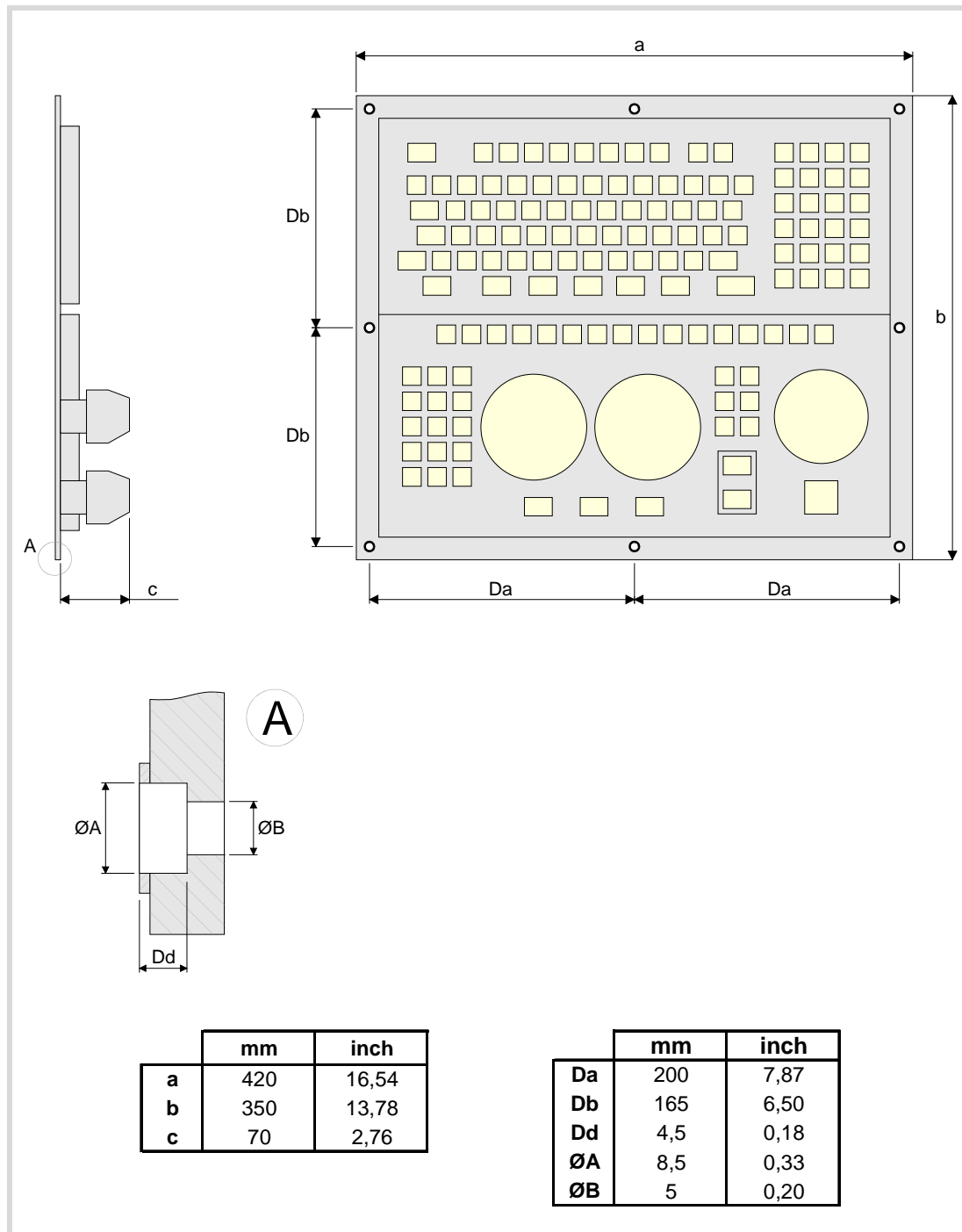

6.

OP-PANEL-H/E MODULE. KEYBOARD AND OPERATOR PANEL.

6.2 Dimensions and characteristics of the enclosure.

The enclosure must meet the following requirements.

- Respect the minimum distances recommended between the enclosure walls and the hardware to allow air flow. This space makes it also possible to bend the cables for the hardware connection with the recommended bending radius.
- Keep the enclosure clean. If the enclosure has ventilation holes, anti-dust filters should be installed in all of them.

6.

OP-PANEL-H/E MODULE. KEYBOARD AND OPERATOR PANEL.

Minimum gaps recommended between the enclosure walls and the hardware.

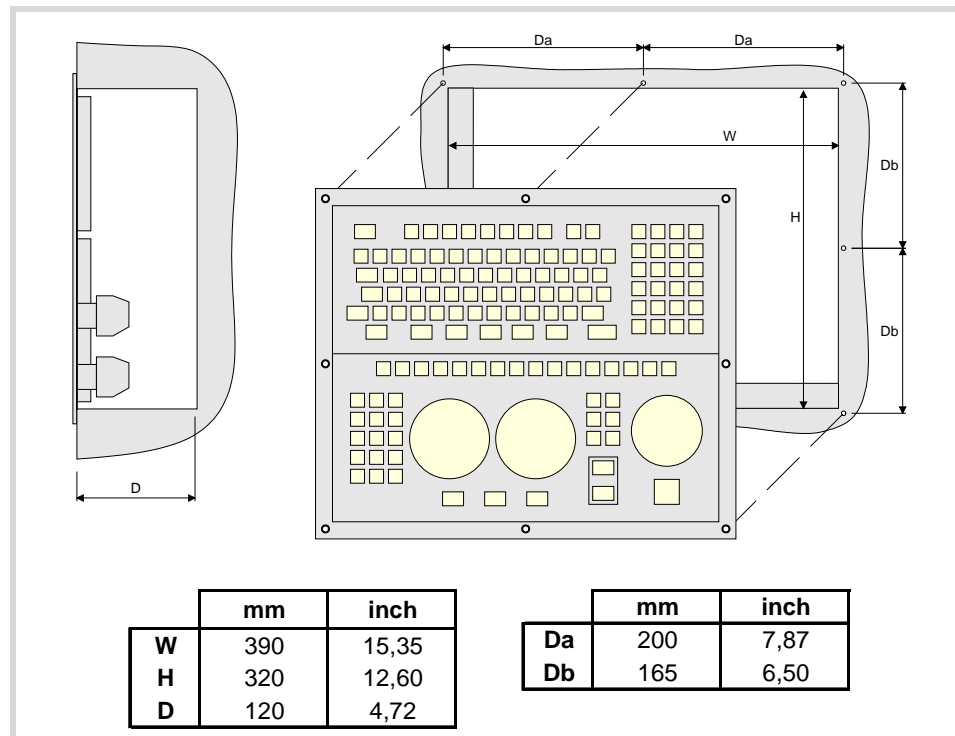

Securing the module.

The module must be installed in a proper enclosure that may be located on the machine or on an external support. To insert the unit into the enclosure, it must have a big enough hole to allow to insert it easily, without obstacles and without forcing the unit.

Once the unit has been inserted into the enclosure, secure it from the outside with M4 or UNC8 screws. To properly secure it, use the mounting holes on the front panel of the unit.

6.3 Elements (connectors).

The connectors are in the rear.

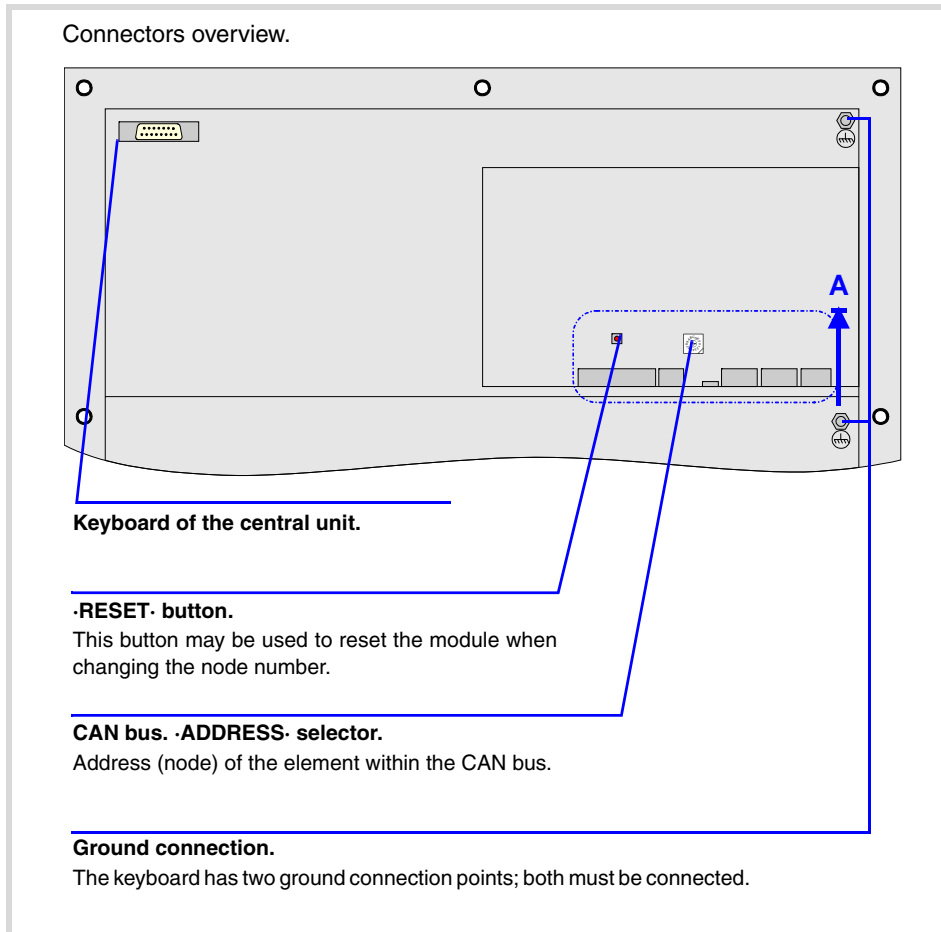

6.

OP-PANEL-H/E MODULE. KEYBOARD AND OPERATOR PANEL.

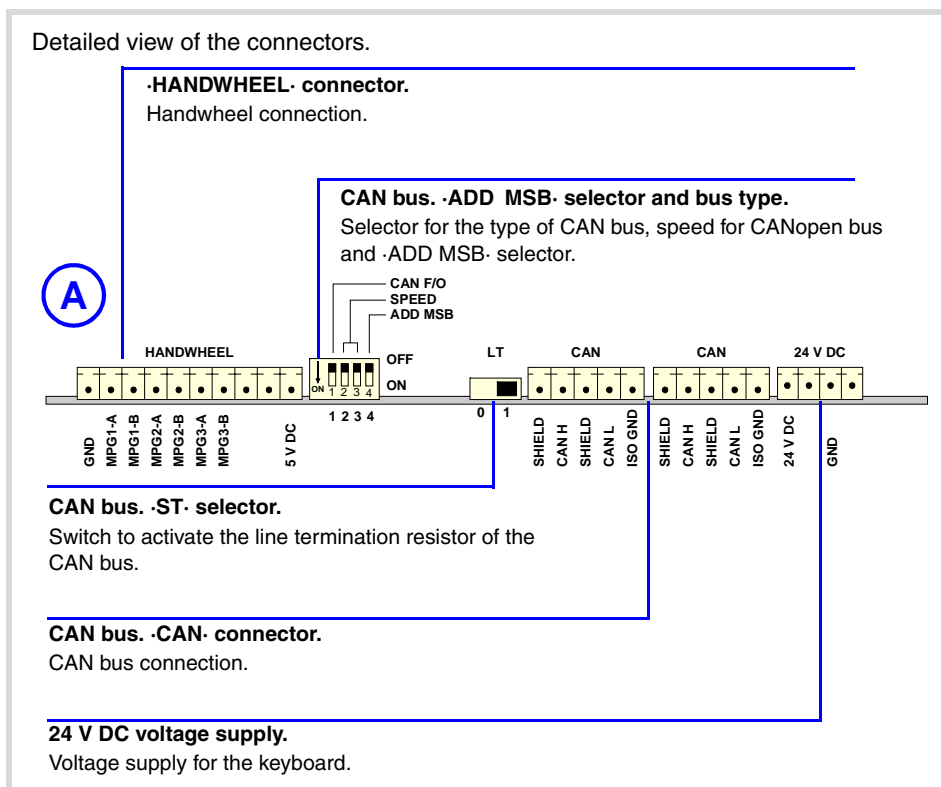

CNC 8070

(REF: 1007)

Keyboard of the central unit (only PC104).

Connection of the keys of the central unit PC104 to the keyboard; not being used in the other central units. Maximum cable length is 1 meter.

Power supply.

4-pin male Phoenix minicombicon contact (3.5 mm pitch).

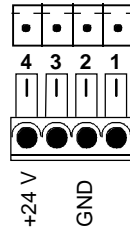

Pin.	Signal.	Function.
1	---	
2	GND	Power supply.
3	---	
4	+ 24 V	Power supply.

Connector to power the keyboard with universal 24 V DC.

CAN bus. ·CAN· connector.

5-pin male Phoenix minicombicon contact (3.5 mm pitch).

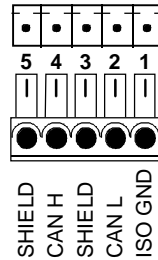

Pin.	Signal.	Function.
1	ISO GND	Ground / 0 V.
2	CAN L	(LOW) bus signal.
3	SHIELD	CAN shield.
4	CAN H	(HIGH) bus signal.
5	SHIELD	CAN shield.

For further information on how to configure the connection of the elements to the CAN bus, refer to chapter "14 Bus CAN (CANfagor/CANopen protocols)." of this manual.

CAN bus. ·ADDRESS· selector. Address (node) of the element within the bus.

Each one of the elements integrated into the CAN bus is identified by the 16-position rotary switch (0-15) "Address" (also referred to as "Node_Select"). With the ADD MSB" switch, the positions or elements integrated in the CAN bus may be expanded up to 32.

The CNC must always occupy position "0" and the rest of the elements of the bus will occupy consecutive positions starting with 1. In order for any change at the "Address" switch to be assumed, the CNC must be restarted and the corresponding drive must be reset, however, we recommend to change the address while the modules and the CNC are off.

The "Address" switch also sets the priority of the group within the bus; the lower the number the higher the priority. We recommend the keyboard and jog panel to be the last node of the bus.

CAN bus. ·ADD MSB· selector Address (node) of the element within the bus.

With the ·4· switch (ADD MSB), the positions or elements integrated in the CAN bus may be expanded up to 32. Positions 0-15 are selected with ADD MSB=0 and positions 16-31 with ADD MSB=1.

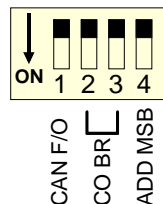

·CAN F/O·	Address (node) of the element.
OFF	Positions 0-15 within the bus.
ON	Positions 16-31 within the bus.

CAN bus. ·ST· selector.

Line terminating resistor. The ·LT· switch identifies which are the elements that occupy the ends of the CAN bus; i.e. the first and last physical element in the connection.

The switch position of the terminating elements must be "1" and that of the rest of the elements "0".

6.

OP-PANEL-H/E MODULE. KEYBOARD AND OPERATOR PANEL.



CNC 8070

(REF: 1007)

CAN bus. Bus type selector: CANfagor / CANopen.

Switch ·1· (CAN F/O) selects the type of CAN bus to be used, i.e. CANfagor or CANopen.

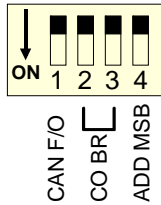

·CAN F/O·	Type of CAN bus.
OFF	The CANfagor bus has been selected.
ON	The CANopen bus has been selected.

CAN bus. Selecting the baudrate for the CANopen bus.

When using the CANopen protocol, the transmission speed at the bus is defined in each node and they all must run at the same speed. The speed is selected with switches ·2· and ·3· (CO BR).

The transmission speed depends on the total length of the bus. Using the following illustrative values; assigning other values may cause communication errors due to signal distortion.

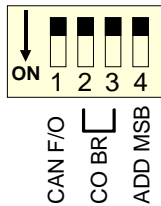

·CO BR·	Speed	Length of the CAN bus.
OFF ON <input type="checkbox"/> <input type="checkbox"/> 2 3	1000 kHz	Up to 20 meters.
OFF ON <input type="checkbox"/> <input type="checkbox"/> 2 3	800 kHz	From 20 to 40 meters.
OFF ON <input type="checkbox"/> <input type="checkbox"/> 2 3	500 kHz	From 40 to 100 meters.
OFF ON <input type="checkbox"/> <input type="checkbox"/> 2 3	250 kHz	From 100 to 500 meters.

In order for any change of speed to be assumed, the corresponding module must be reset; however, we recommend to change the speed while the modules and the CNC are off.

·RESET· button.

The ·RESET· button may be used to reset the module after changing the node address or the baudrate of the bus; however, it is recommended to change the address or the baudrate while the modules and the CNC are off.

·HANDWHEEL· connector. Handwheel connection.

10-pin male Phoenix minicombicon contact (3.5 mm pitch).

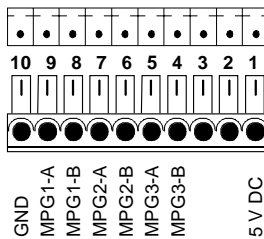

Pin	Signal	Function
1	+5 V	Power supply.
2	- - -	
3	- - -	
4	MPG3-B	B signal of the third handwheel.
5	MPG3-A	A signal of the third handwheel.
6	MPG2-B	B signal of the second handwheel.
7	MPG2-A	A signal of the second handwheel.
8	MPG1-B	B signal of the first handwheel.
9	MPG1-A	A signal of the first handwheel.
10	GND	Power supply.

The keyboard admits the connection of up to 3 handwheels (MPG1, MPG2 and MPG3) with A and B signals (5 V DC TTL). If the handwheel has an axis selector button, the button signal may be connected to a digital input and may be managed from the PLC using the -NEXTMPGAXIS-mark.

7 KB-PANEL-H MODULE. INDEPENDENT KEYBOARD.

7.

KB-PANEL-H MODULE. INDEPENDENT KEYBOARD.

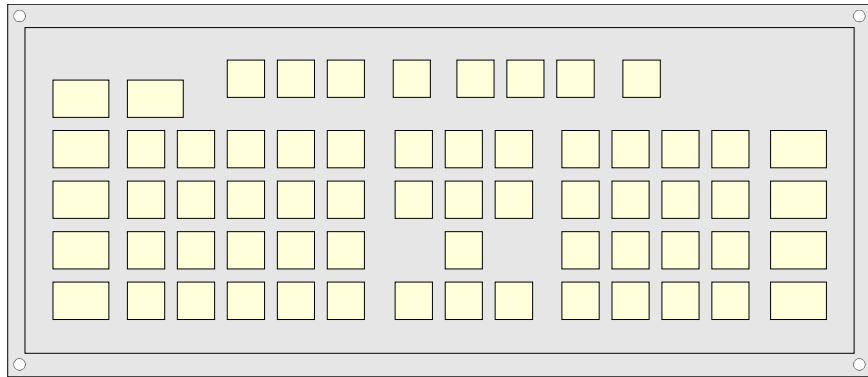

General characteristics.

Connection.	Connection to the central unit through PS-2 connector.
Degree of protection.	It meets the protection standard IP 54.



The machine manufacturer must comply with the EN 60204-1 (IEC-204-1) regulation regarding electrical shocks in case of defective input/output pins with external power supply when not plugging the connector before turning the power supply on.

7.1 Hardware dimensions.

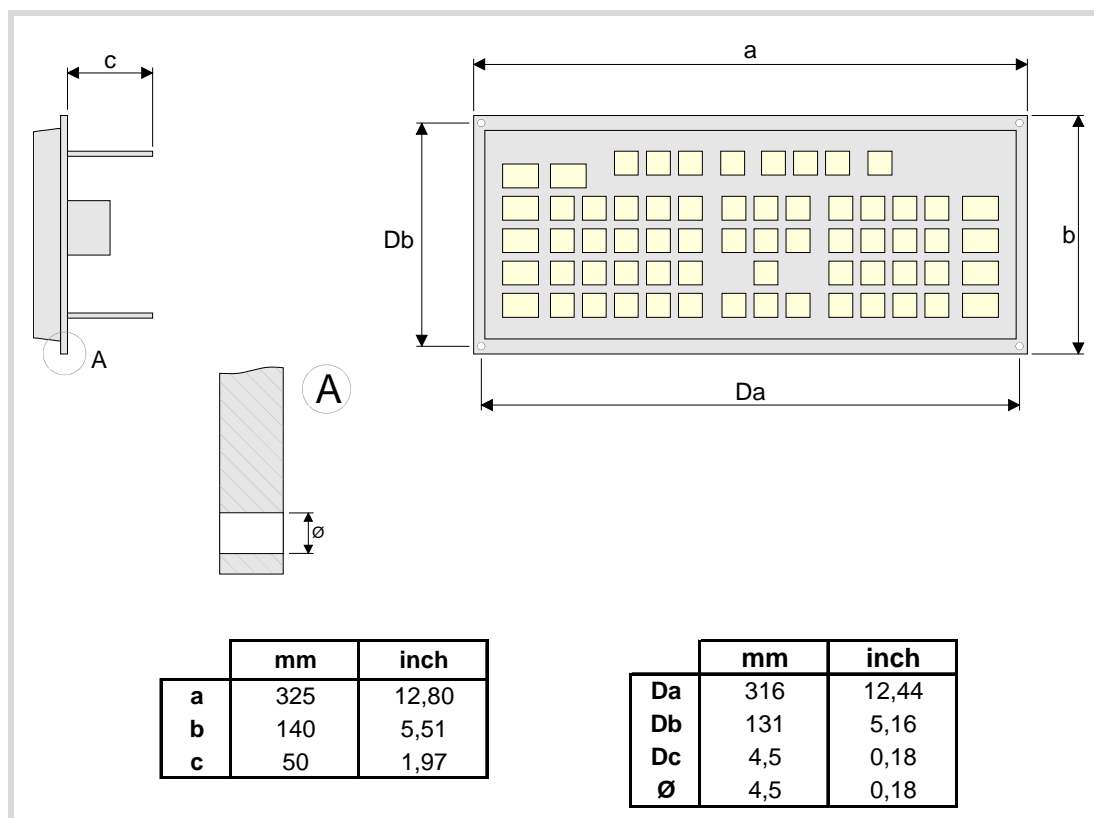

7.

KB-PANEL-H MODULE. INDEPENDENT KEYBOARD.



CNC 8070

(REF: 1007)

7.2 Dimensions and characteristics of the enclosure.

The enclosure must meet the following requirements.

- Respect the minimum distances recommended between the enclosure walls and the hardware to allow air flow. This space makes it also possible to bend the cables for the hardware connection with the recommended bending radius.
- Keep the enclosure clean. If the enclosure has ventilation holes, anti-dust filters should be installed in all of them.

Minimum gaps recommended between the enclosure walls and the hardware.

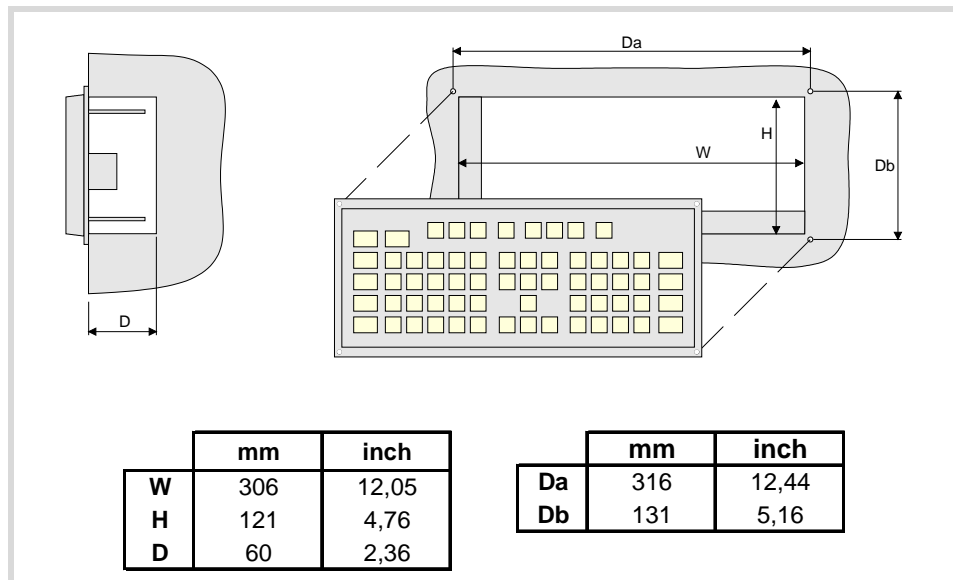

Securing the module.

The module must be installed in a proper enclosure that may be located on the machine or on an external support. To insert the unit into the enclosure, it must have a big enough hole to allow to insert it easily, without obstacles and without forcing the unit.

Once the unit has been inserted into the enclosure, secure it from the outside with M4 or UNC8 screws. To properly secure it, use the mounting holes on the front panel of the unit.

7.3 Elements (connectors).

The connectors are in the rear.

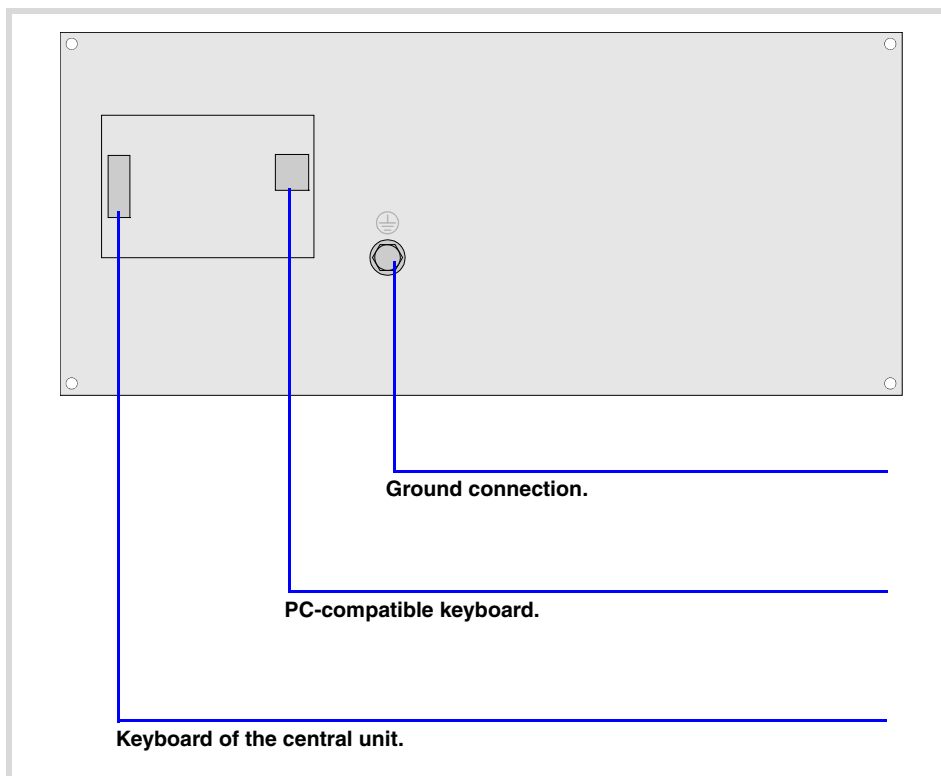

Keyboard of the central unit (only PC104).

Connection of the keys of the central unit PC104 to the keyboard; not being used in the other central units. Maximum cable length is 1 meter.

PC-compatible keyboard.

6-pin minidin female connector.

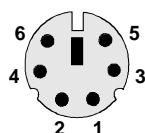

Pin.	Signal.
1	Keyboard data.
2	- - -
3	GND
4	+5 V
5	Keyboard clock.
6	- - -

7.

KB-PANEL-H MODULE. INDEPENDENT KEYBOARD.



CNC 8070

(REF: 1007)

8 JOG-PANEL MODULE. INDEPENDENT OPERATOR PANEL.

Independent operator panel with the possibility to connect up to three electronic handwheels.

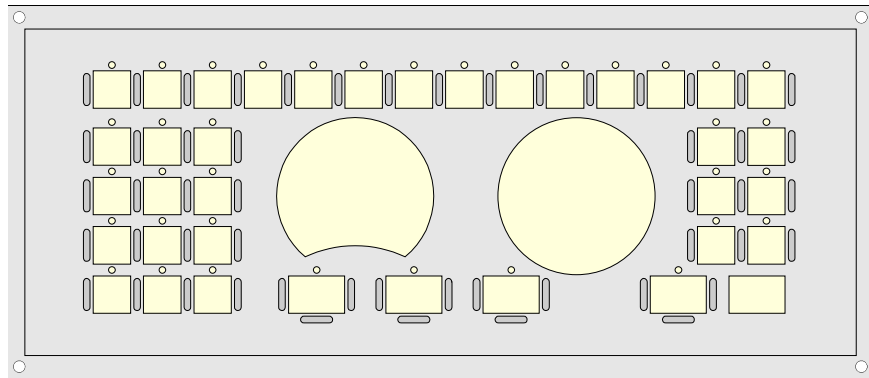

General characteristics.

Power supply.	24 Vdc universal power supply.
Connection.	Connection to the central unit through CAN bus.
Electronic handwheels.	Possibility to connect up to three handwheels with A and B signals (5 V DC TTL).
Degree of protection.	It meets the protection standard IP 54.



The machine manufacturer must comply with the EN 60204-1 (IEC-204-1) regulation regarding electrical shocks in case of defective input/output pins with external power supply when not plugging the connector before turning the power supply on.

8.1 Hardware dimensions.

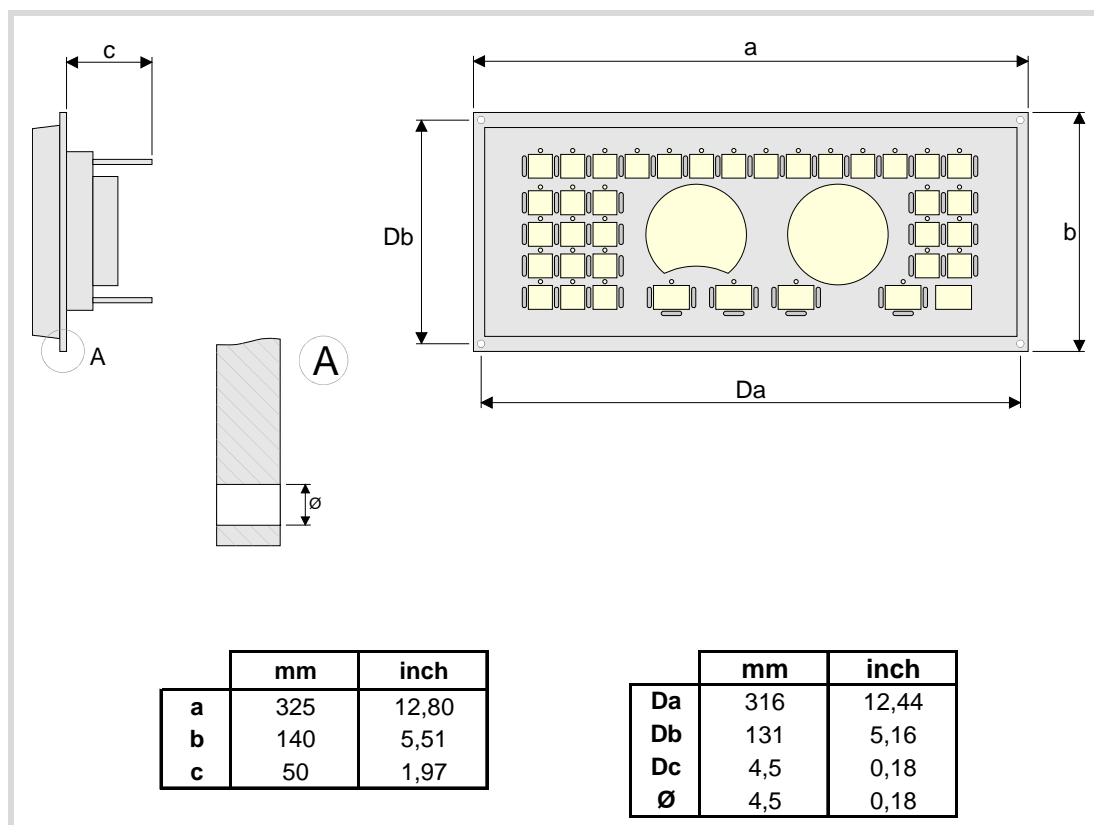

8.

JOG-PANEL MODULE: INDEPENDENT OPERATOR PANEL.

FAGOR 

CNC 8070

(REF: 1007)

8.2 Dimensions and characteristics of the enclosure.

The enclosure must meet the following requirements.

- Respect the minimum distances recommended between the enclosure walls and the hardware to allow air flow. This space makes it also possible to bend the cables for the hardware connection with the recommended bending radius.
- Keep the enclosure clean. If the enclosure has ventilation holes, anti-dust filters should be installed in all of them.

Minimum gaps recommended between the enclosure walls and the hardware.

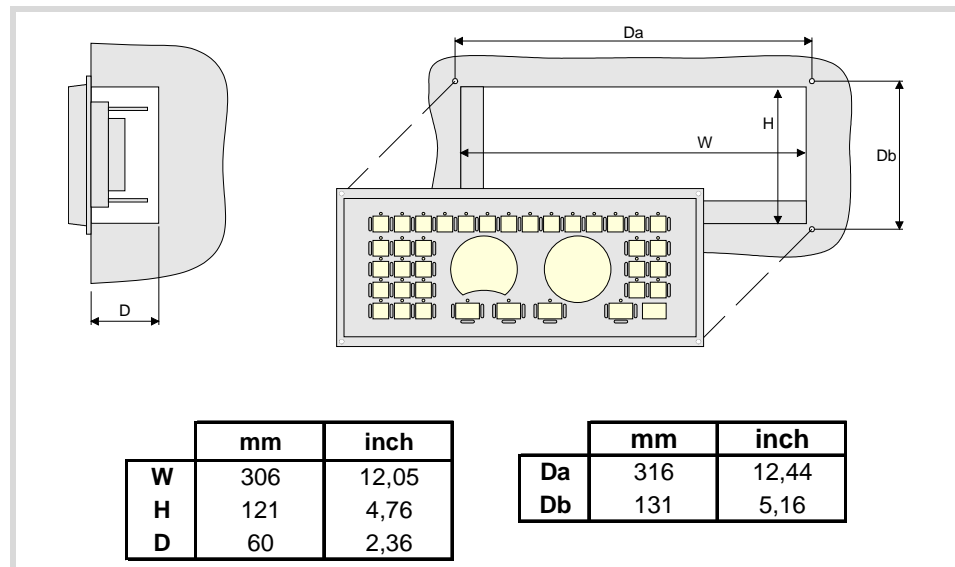

Securing the module.

The module must be installed in a proper enclosure that may be located on the machine or on an external support. To insert the unit into the enclosure, it must have a big enough hole to allow to insert it easily, without obstacles and without forcing the unit.

Once the unit has been inserted into the enclosure, secure it from the outside with M4 or UNC8 screws. To properly secure it, use the mounting holes on the front panel of the unit.

8.3 Elements (connectors).

The connectors are in the rear.

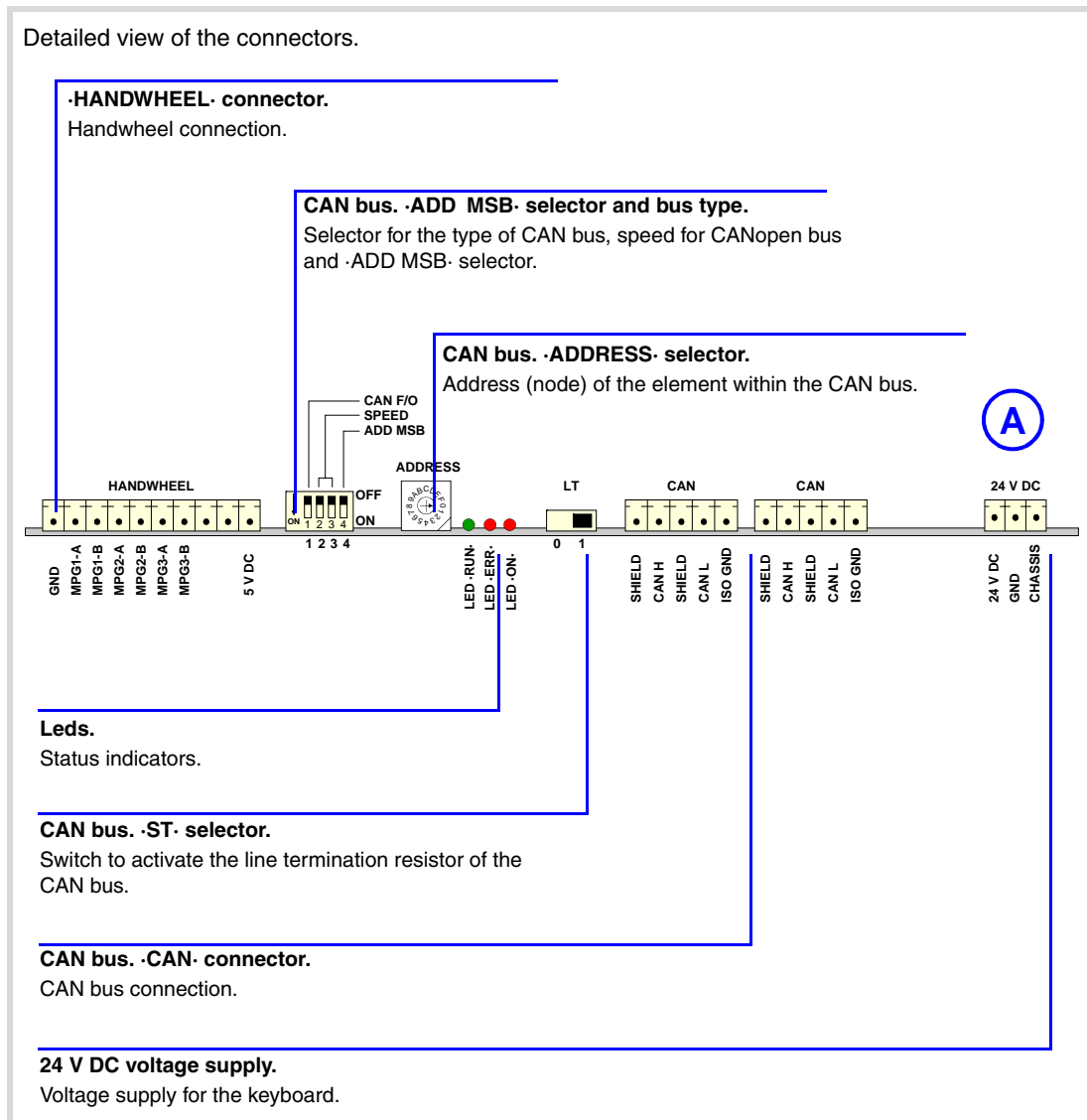
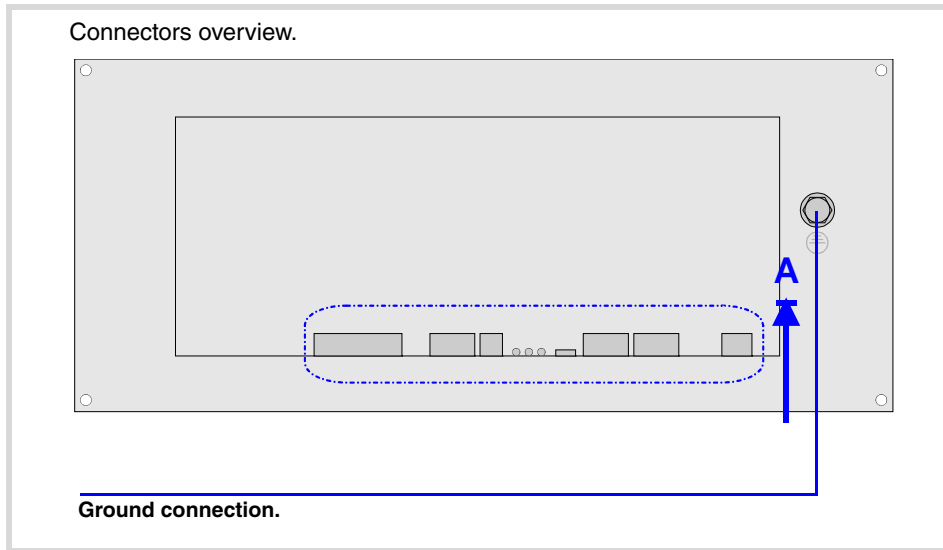

8.

JOG-PANEL MODULE: INDEPENDENT OPERATOR PANEL:



CNC 8070

(REF: 1007)

Power supply.

3-pin male Phoenix minicombicon contact (3.5 mm pitch).

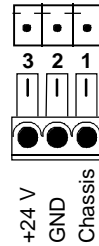

Pin.	Signal.	Function.
1	Chassis.	Chassis.
2	GND	Power supply.
3	+ 24 V (IN)	Power supply.

Connector to power the keyboard with universal 24 V DC. The ·ON· LED stays on when the module is under voltage.

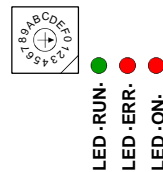
·ON· LED. Operator panel powered.

Red LED. This LED turns on when the operator panel is under voltage.

CAN bus. ·CAN· connector.

5-pin male Phoenix minicombicon contact (3.5 mm pitch).

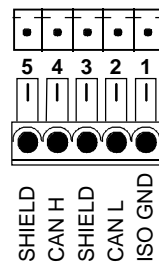

Pin.	Signal.	Function.
1	ISO GND	Ground / 0 V.
2	CAN L	(LOW) bus signal.
3	SHIELD	CAN shield.
4	CAN H	(HIGH) bus signal.
5	SHIELD	CAN shield.

For further information on how to configure the connection of the elements to the CAN bus, refer to chapter "14 Bus CAN (CANfagor/CANopen protocols)." of this manual.

CAN bus. ·ADDRESS· selector. Address (node) of the element within the bus.

Each one of the elements integrated into the CAN bus is identified by the 16-position rotary switch (0-15) "Address" (also referred to as "Node_Select"). With the ADD MSB" switch, the positions or elements integrated in the CAN bus may be expanded up to 32.

The CNC must always occupy position "0" and the rest of the elements of the bus will occupy consecutive positions starting with 1. In order for any change at the "Address" switch to be assumed, the CNC must be restarted and the corresponding drive must be reset, however, we recommend to change the address while the modules and the CNC are off.

The "Address" switch also sets the priority of the group within the bus; the lower the number the higher the priority. We recommend the keyboard and jog panel to be the last node of the bus.

CAN bus. ·ADD MSB· selector Address (node) of the element within the bus.

With the ·4· switch (ADD MSB), the positions or elements integrated in the CAN bus may be expanded up to 32. Positions 0-15 are selected with ADD MSB=0 and positions 16-31 with ADD MSB=1.

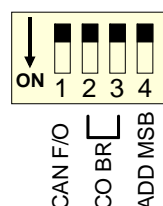

·CAN F/O·	Address (node) of the element.
OFF	Positions 0-15 within the bus.
ON	Positions 16-31 within the bus.

8.

JOG-PANEL MODULE. INDEPENDENT OPERATOR PANEL.



CNC 8070

(REF: 1007)

CAN bus. ·ST· selector.



Line terminating resistor. The ·LT· switch identifies which are the elements that occupy the ends of the CAN bus; i.e. the first and last physical element in the connection.

The switch position of the terminating elements must be "1" and that of the rest of the elements "0".

CAN bus. Bus type selector: CANfagor / CANopen.

Switch ·1· (CAN F/O) selects the type of CAN bus to be used, i.e. CANfagor or CANopen.

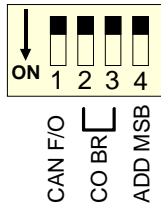

·CAN F/O·	Type of CAN bus.
OFF	The CANfagor bus has been selected.
ON	The CANopen bus has been selected.

CAN bus. Selecting the baudrate for the CANopen bus.

When using the CANopen protocol, the transmission speed at the bus is defined in each node and they all must run at the same speed. The speed is selected with switches ·2· and ·3· (CO BR).

The transmission speed depends on the total length of the bus. Using the following illustrative values; assigning other values may cause communication errors due to signal distortion.

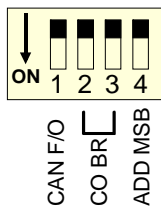

·CO BR·	Speed	Length of the CAN bus.
OFF ON 2 3	1000 kHz	Up to 20 meters.
OFF ON 2 3	800 kHz	From 20 to 40 meters.
OFF ON 2 3	500 kHz	From 40 to 100 meters.
OFF ON 2 3	250 kHz	From 100 to 500 meters.

In order for any change of speed to be assumed, the corresponding module must be reset; however, we recommend to change the speed while the modules and the CNC are off.

Led ·ERR·. Status indicator LED.

Red LED. Its meaning depends on the blinking speed.

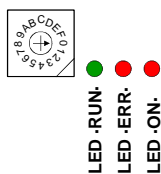

Type of blinking.	Meaning
LED off.	The module works properly.
Blinking fast.	Module configuration stage.
Single blinking.	Warning. Poor transmission.
Double blinking.	There is no communication with the cpu.
LED on.	Error. Too many errors.

Led ·RUN·. Status indicator LED.

The LED is green. Its meaning depends on the blinking speed.

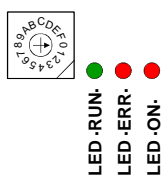

Type of blinking.	Meaning
LED on.	The module works properly.
Single blinking.	Module stopped.
Blinking fast.	Module configuration stage.
Continuous blinking.	Start-up stage or error.

·HANDWHEEL· connector. Handwheel connection.

10-pin male Phoenix minicombicon contact (3.5 mm pitch).

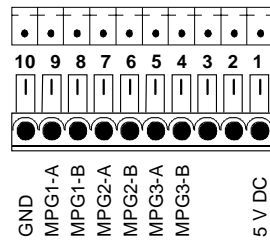

Pin	Signal	Function
1	+5 V	Power supply.
2	- - -	
3	- - -	
4	MPG3-B	B signal of the third handwheel.
5	MPG3-A	A signal of the third handwheel.
6	MPG2-B	B signal of the second handwheel.
7	MPG2-A	A signal of the second handwheel.
8	MPG1-B	B signal of the first handwheel.
9	MPG1-A	A signal of the first handwheel.
10	GND	Power supply.

The keyboard admits the connection of up to 3 handwheels (MPG1, MPG2 and MPG3) with A and B signals (5 V DC TTL). If the handwheel has an axis selector button, the button signal may be connected to a digital input and may be managed from the PLC using the -NEXTMPGAXIS-mark.

8.

JOG-PANEL MODULE. INDEPENDENT OPERATOR PANEL.



CNC 8070

(REF: 1007)

9 MOUSE MODULE.

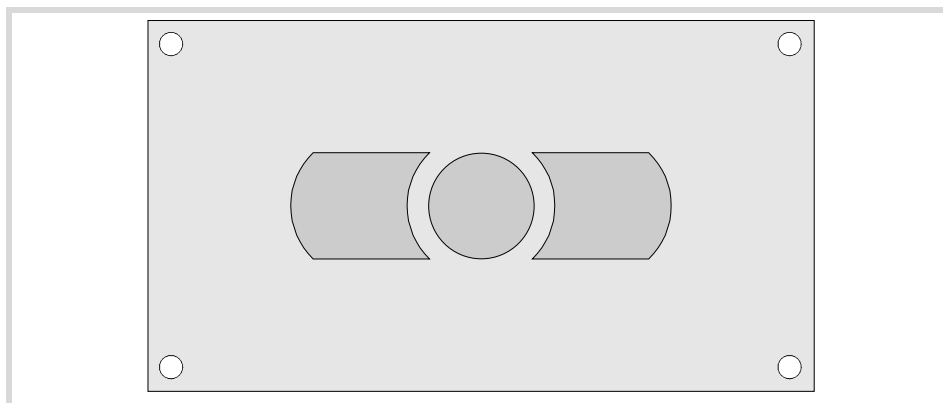

General characteristics.

Connection. Connection to the central unit through PS-2 connector.

9.
MOUSE MODULE:

9.1 Hardware dimensions.

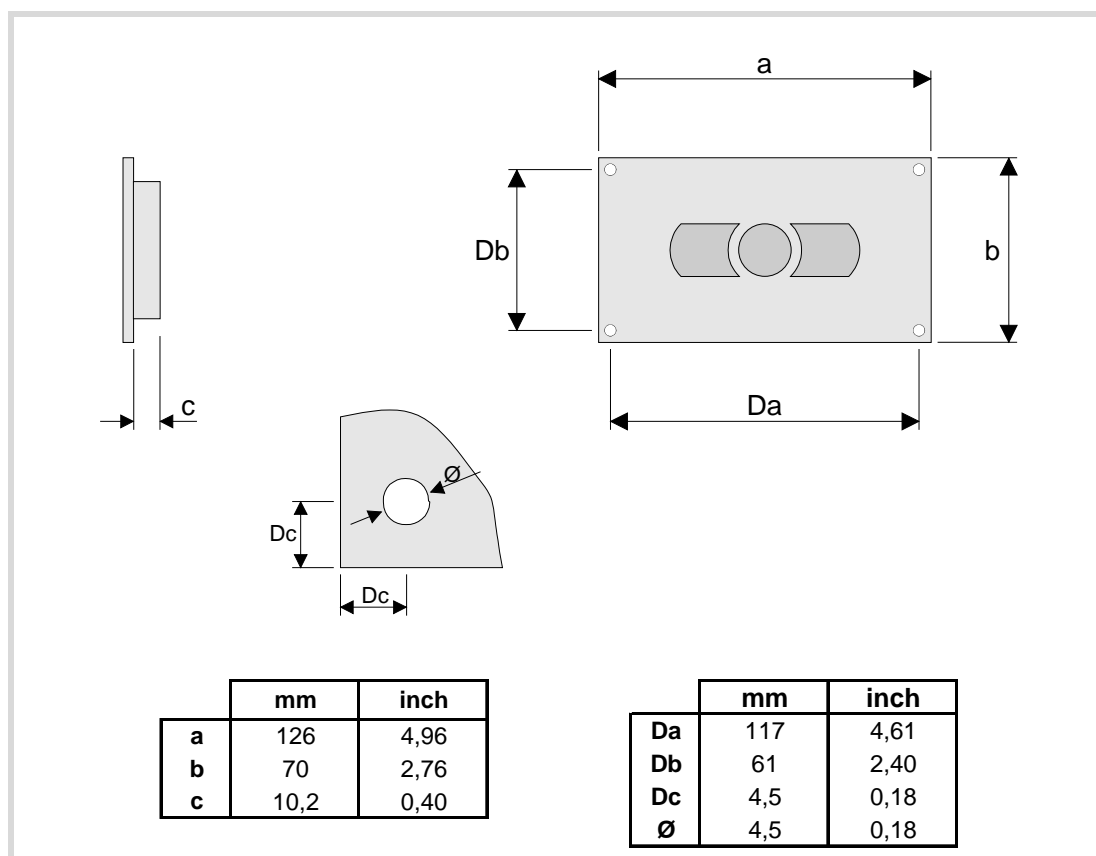

FAGOR 

CNC 8070

(REF: 1007)

10 RIO70 REMOTE MODULES. (CANFAGOR PROTOCOL).

Remote modules may be used to have an additional number of digital and analog inputs and outputs (remote I/O) that, distributed at different points of the machine or mounted in the cabinet, permit controlling various devices of the machine. The remote modules are distributed by groups (nodes) and are connected to the central unit through the CAN bus that can have up to 32 nodes, including the central unit and the keyboards. The following elements may be available with RIO70 series modules.

Type of input/output	Amount.
Digital inputs.	1024
Digital outputs.	1024
General purpose analog inputs.	60
Analog outputs.	40
Feedback inputs.	40

Fagor remote modules, RIO70 series, available for CAN bus with CANfagor protocol.

There are full-size modules (those occupying the whole box) and half-size modules (occupying half the box). Two half-size modules may be mounted in a box. Each group may have up to 5 complete modules depending on consumption. See "10.2 Consumption of the remote modules." on page 106.

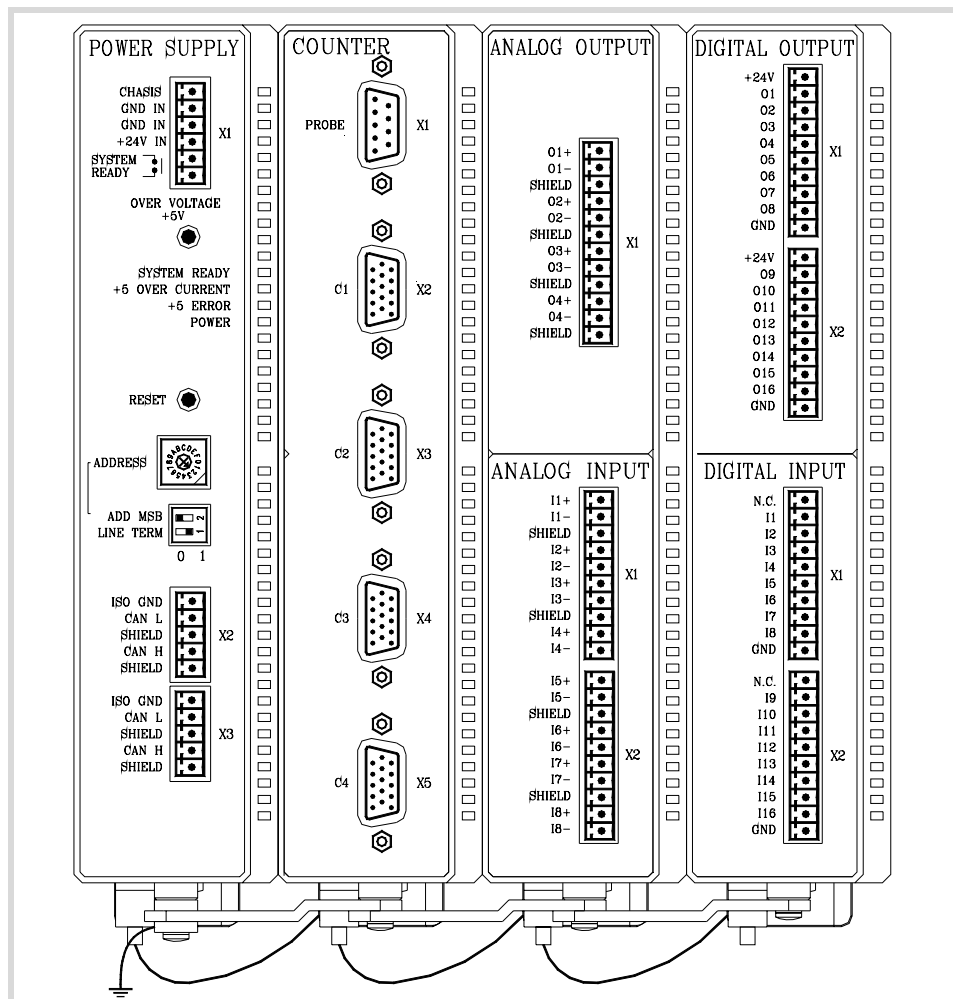

RIO70 REMOTE MODULES. (CANFAGOR PROTOCOL).

10.



CNC 8070

(REF: 1007)

Fagor supplies all types of possible combinations with half-size modules, even units with a single half-size module (the other half will be a cover). The available modules are the following.

- Power supply.
The power supply module must be present in each group. This module must be powered at 24 V DC and connected to the system CAN bus.
- Feedback inputs.
Each module has 4 feedback inputs.
- Digital inputs. Half size.
Each module has 16 digital inputs.
- Digital outputs. Half size.
Each module has 16 digital outputs.
- Analog inputs. Half size.
Each module has 8 analog inputs.
- Analog outputs. Half size.
Each module has 4 analog outputs.

Probe connection.

The digital inputs let you handle the signal of the two 24 V DC probes . Use machine parameters to define which digital input is associated with each probe and their type of pulse.

10.

RIO70 REMOTE MODULES. (CANFAGOR PROTOCOL).

10.1 Dimensions and mounting of the modules.

Place the modules on 2 profiles, according to the UNE 50022 standard, with 2 securing ends, one at each end of the group; they help securing the modules besides maintaining the right gap between the profiles. The mounting order to be followed from left to right is:

- Power Supply.
- Counters.
- Analog outputs. Half size.
- Analog inputs. Half size.
- Digital outputs. Half size.
- Digital inputs. Half size.

Dimensions of the modules.

Always leave a 140 mm gap under the modules for ventilation and later handling.

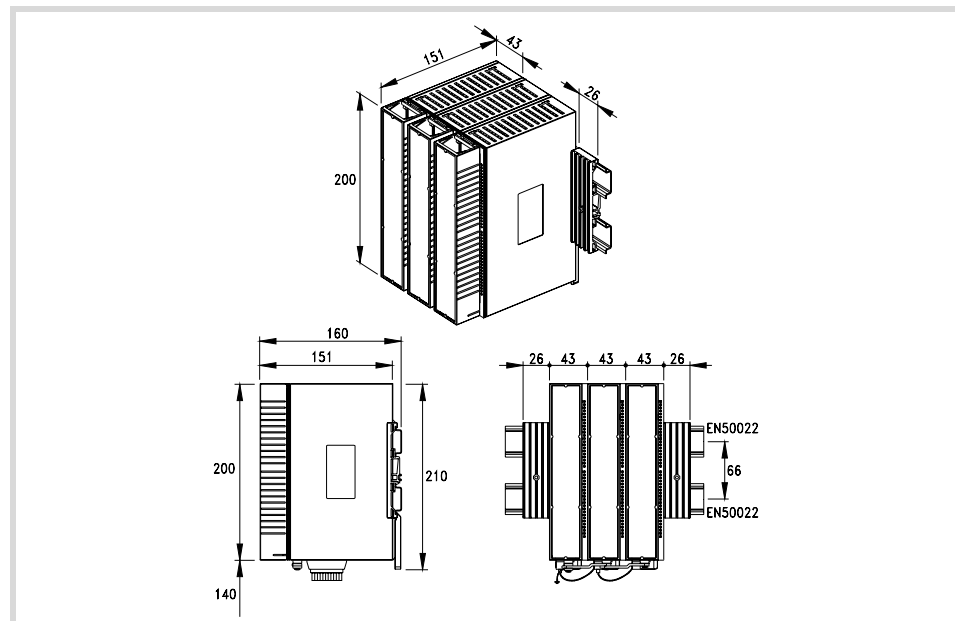

Connection of the modules.

The modules of the group are connected as follows:

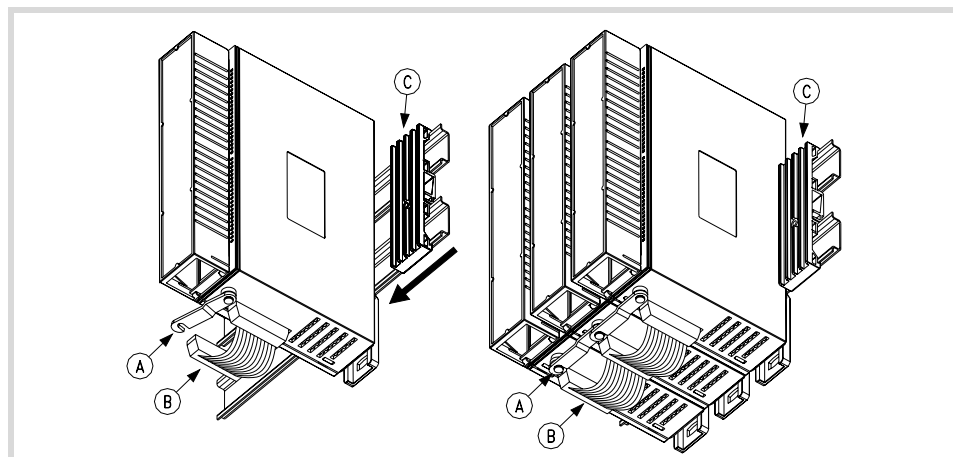

- A For ground connection.
- B Ribbon cable to interconnect the modules.
- C Securing ends.

10.

RIO70 REMOTE MODULES. (CANFAGOR PROTOCOL).

FAGOR 

CNC 8070

(REF: 1007)

Each group is connected to the system (CPU, Keyboard, etc.) through the CAN bus as described later on.



DO NOT make any connection or connect any module to the power supply while the latter is turned on. Before making any connection, ribbon cable included, turn the power supply off by unplugging the power cable.

10.

RIO70 REMOTE MODULES. (CANFAGOR PROTOCOL).

FAGOR

CNC 8070

(REF: 1007)

10.2 Consumption of the remote modules.

The power supply is in charge of supplying to the rest of the modules through +5 V and ± 18 V and managing the internal bus of the group. The total consumption of the group depends on the configuration of the modules.

	5 V	± 18 V
(DI) Digital inputs.	0,40 watts	- - -
(DO) Digital outputs.	0,65 watts	- - -
(AI) Analog inputs.	0,3 watts	1,8 watts
(AO) Analog outputs.	0,35 watts	3,4 watts
(CT) Counters.	1,75 watts	- - -
(CPU) CPU-CAN.	0,6 watts	- - -

The consumption of the CPU-CAN is added to each module of the configuration. When mounting two half-size modules together (in the same box), the consumption of the CPU-CAN must only be added once.

The total consumption of the group must not exceed the following maximums. If any of them is exceeded, double the group. Use two power supplies and distribute the modules.

- For +5 V, a maximum consumption of 10 watts.
- For 18 V, a maximum consumption of 7.2 watts.

Example.

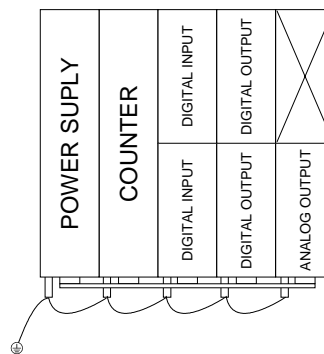

Modules.	5 V	± 18 V
(CT) + (CPU)	$1,75 + 0,6$	- - -
(DI) + (DI) +(CPU)	$0,4 + 0,4 + 0,6$	- - -
(DO) + (DO) + (CPU)	$0,65 + 0,65 + 0,6$	- - -
(AO) + (CPU)	$0,35 + 0,6$	3,4
Total consumption	6,60 watts	3,4 watts

10.

RIO70 REMOTE MODULES. (CANFAGOR PROTOCOL).

10.3 Power Supply.

The power supply must be present in all the configurations (1 per group), it must be powered at 24 Vdc and connected to the CAN bus of the system.

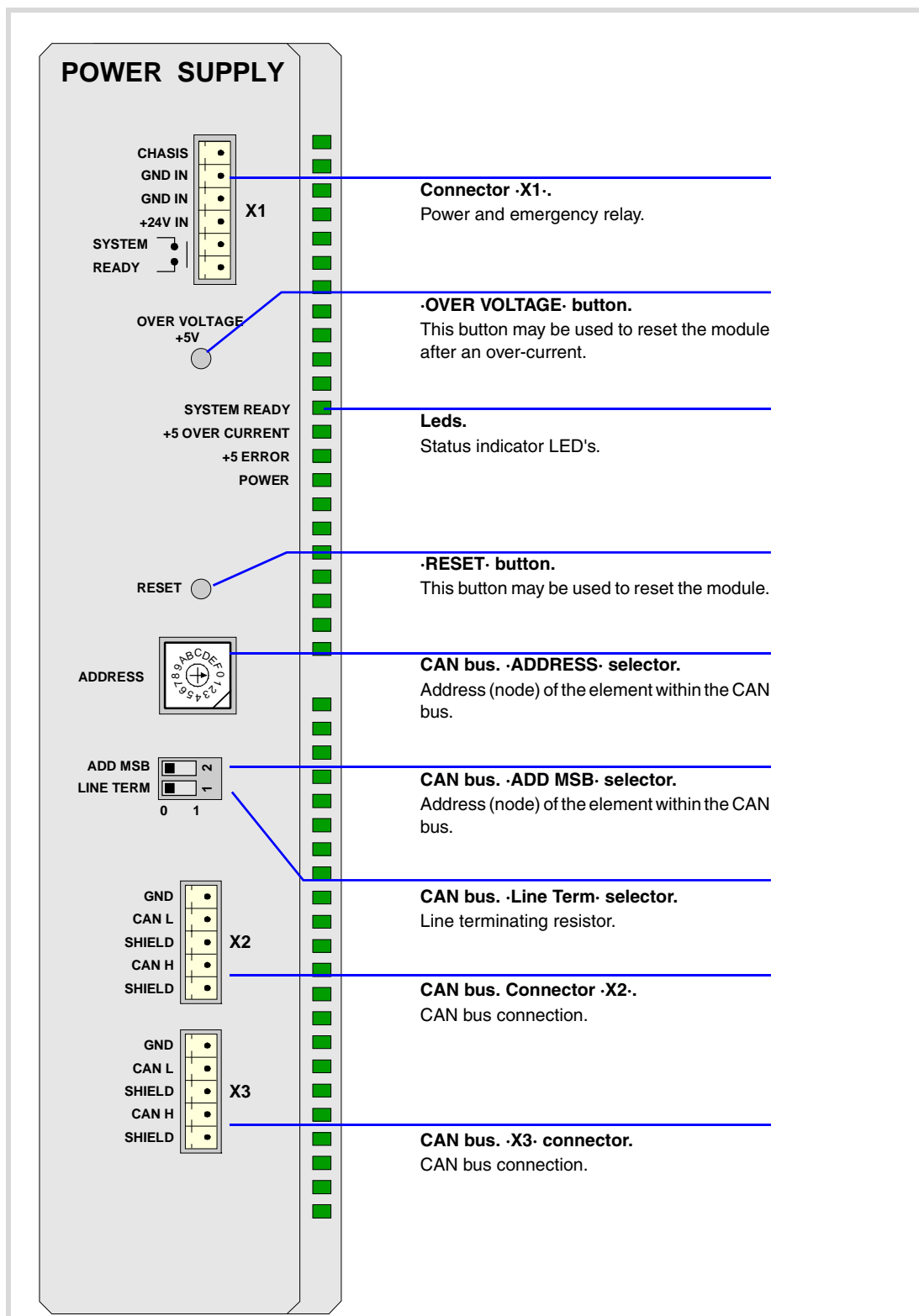

10.

RIO70 REMOTE MODULES. (CANFAGOR PROTOCOL).



CNC 8070

(REF: 1007)

10.3.1 Elements (connectors).

Connector ·X1·. Power and emergency relay.

6-pin male Phoenix minicombicon contact (3.5 mm pitch).

CHASSIS	1	—	●	Signal.	Function.
GND IN	2	—	●	Chassis	Shield.
GND IN	3	—	●	GND IN	Power input.
+24 V IN	4	—	●	GND IN	Power input.
SYSTEM READY	5	—	●	+ 24 V	Power input.
READY	6	—	●	System Ready	Relay for the emergency chain.

The relay may be used to connect the modules to the emergency chain of the electrical cabinet. The relay is an internal contact that closes when the group is ready; it opens again when an internal failure occurs.

·OVER VOLTAGE· button and status LED.

This button may be used to reactivate the power supply after an over-current. An over-current activates the safety device inside the power supply turns on the external red LED. The power supply will not be operative while the LED is on. There are two ways to reactivate the power supply after an over-current.

- Unplug the power supply from mains and wait for about 30 seconds until the red light turns off.
- Unplug the power supply and press the button. The red LED will turn off indicating that the power supply is ready.

If after reactivating the power supply, the LED turns back on, call the Technical Service Department.

·SYSTEM READY· LED. Module under power.

SYSTEM READY ■ The LED is green. This LED blinks when the module is under power.
 +5 OVER CURRENT ■
 + 5 ERROR ■
 POWER ■

·OVER CURRENT· LED. Over-current at the power supply.

SYSTEM READY ■ Red LED. This LED turns on when the +5 V power supply is outputting the maximum current.
 +5 OVER CURRENT ■
 + 5 ERROR ■
 POWER ■

·ERROR· LED. Error at the power supply.

SYSTEM READY ■ Red LED. This LED turns on when the power supply is not capable of supplying the 5 V DC due to a current overload
 +5 OVER CURRENT ■
 + 5 ERROR ■ To eliminate the error, remove the load from the power supply or duplicate the group.
 POWER ■

·POWER· LED. Status of the 5 V.

SYSTEM READY ■ The LED is green. This LED turns on when the +5 V power supply is working properly.
 +5 OVER CURRENT ■
 + 5 ERROR ■
 POWER ■

·RESET· button.

The ·RESET· button may be used to reset the module after changing the node address; however, it is recommended to change the address while the modules and the CNC are off.

10.

RIO70 REMOTE MODULES. (CANFAGOR PROTOCOL).



CNC 8070

(REF: 1007)

CAN bus. ADDRESS selector. Address (node) of the element within the bus.



Each one of the elements integrated into the CAN bus is identified by the 16-position rotary switch (0-15) "Address" (also referred to as "Node_Select"). With the ADD MSB switch, the positions or elements integrated in the CAN bus may be expanded up to 32.

The CNC must always occupy position "0" and the rest of the elements of the bus will occupy consecutive positions starting with 1. In order for any change at the "Address" switch to be assumed, the CNC must be restarted and the corresponding drive must be reset, however, we recommend to change the address while the modules and the CNC are off.

The "Address" switch also sets the priority of the group within the bus; the lower the number the higher the priority. We recommend the keyboard and jog panel to be the last node of the bus.

CAN bus. ADD MSB selector Address (node) of the element within the bus.

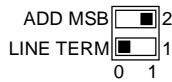

With the 2-position switch (ADD MSB), the positions or elements integrated in the CAN bus may be expanded up to 32. Positions 0-15 are selected with ADD MSB=0 and positions 16-31 with ADD MSB=1.

ADD MSB	Address (node) of the element.
OFF	Positions 0-15 within the bus.
ON	Positions 16-31 within the bus.

CAN bus. Line Term selector.

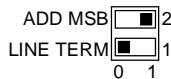

Line terminating resistor. The LT switch identifies which are the elements that occupy the ends of the CAN bus; i.e. the first and last physical element in the connection.

The switch position of the terminating elements must be "1" and that of the rest of the elements "0".

CAN bus. CAN connector. Connector X2 & X3.

5-pin male Phoenix minicombicon contact (3.5 mm pitch).

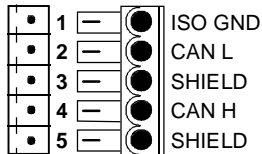

Pin.	Signal.	Function.
1	ISO GND	Ground / 0 V.
2	CAN L	(LOW) bus signal.
3	SHIELD	CAN shield.
4	CAN H	(HIGH) bus signal.
5	SHIELD	CAN shield.

For further information on how to configure the connection of the elements to the CAN bus, refer to chapter "14 Bus CAN (CANfagor/CANopen protocols)." of this manual.

10.4 Digital inputs and outputs.

10.

RIO70 REMOTE MODULES. (CANFAGOR PROTOCOL).

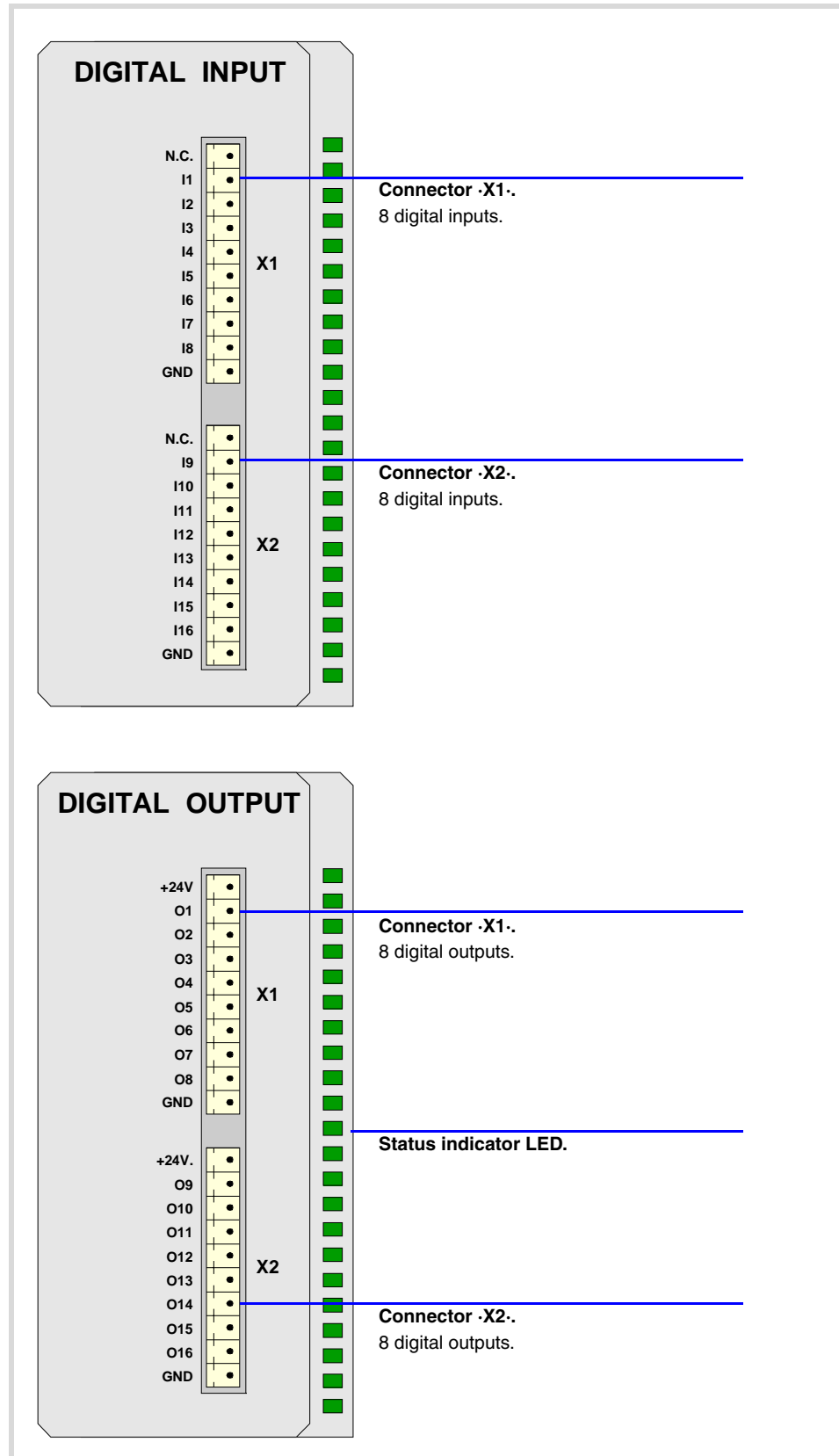

CNC 8070

(REF: 1007)

10.4.1 Elements (connectors).

Connector ·X1· & ·X2·. Digital inputs (8 inputs in each connector).

10-pin male Phoenix minicombicon contact (3.5 mm pitch).

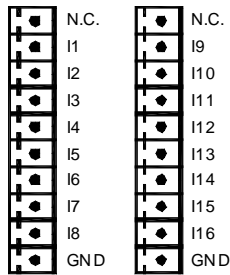

Signal.	Function.
N.C.	Not being used.
I1 - I8	Digital inputs.
I9 - I16	Digital inputs.
GND	0 V reference signal.

Connector ·X1· & ·X2·. Digital outputs (8 outputs in each connector).

10-pin male Phoenix minicombicon contact (3.5 mm pitch). Both connectors must be powered with 24 V DC and GND.

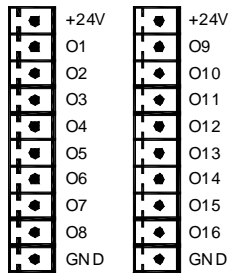

Signal.	Function.
+ 24 V	Power supply.
O1 - O8	Digital outputs.
O9 - O16	Digital outputs.
GND	0 V reference signal.

Status indicator LED.

The green LED located in the middle of the digital output module turns on when the module is powered with 24 Vdc and the inside fuse is OK.

10.

RIO70 REMOTE MODULES. (CANFAGOR PROTOCOL).

10.5 Analog inputs and outputs.

10.

RIO70 REMOTE MODULES. (CANFAGOR PROTOCOL).

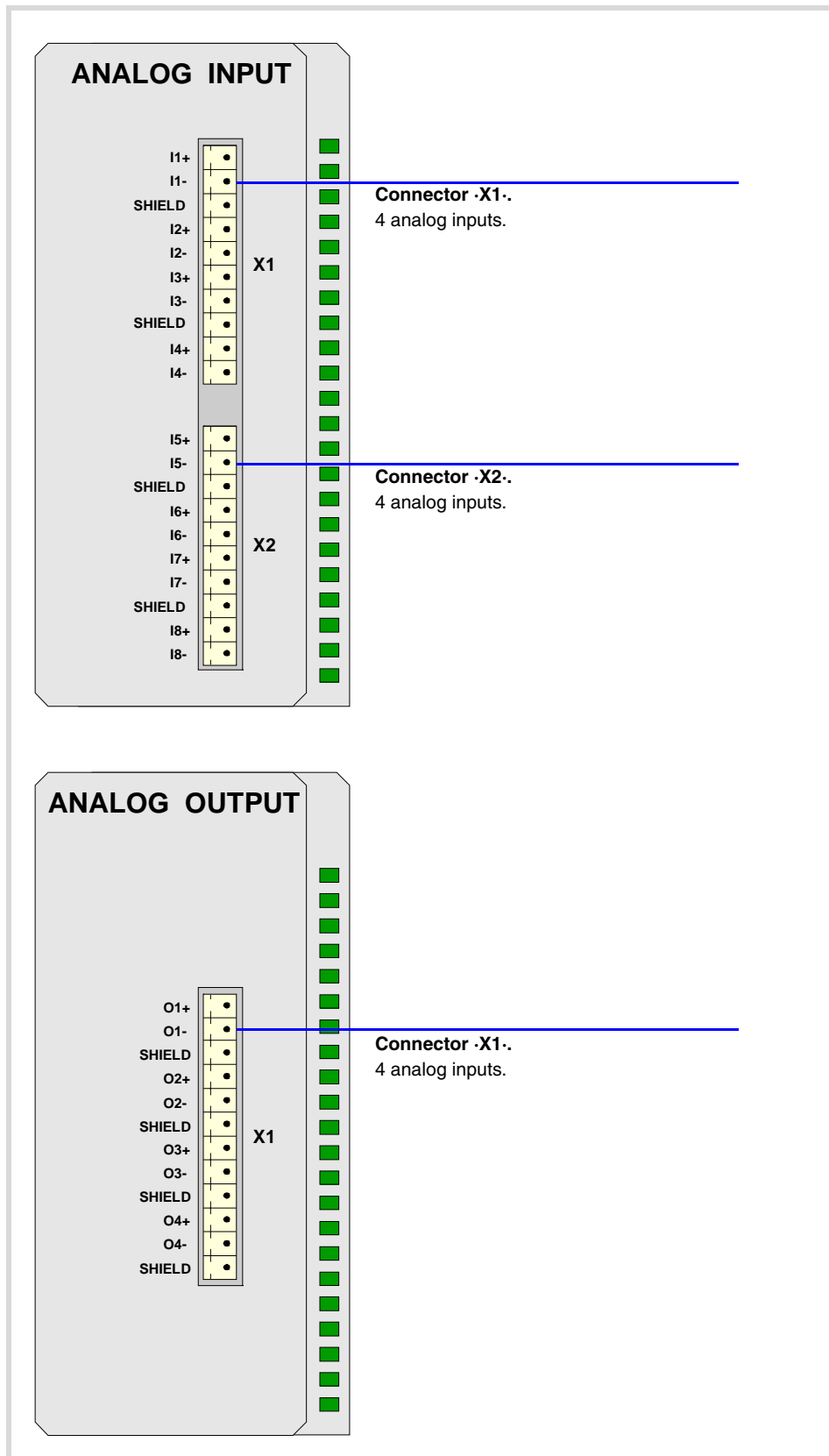

CNC 8070

(REF: 1007)

10.5.1 Elements (connectors).

Connector ·X1· & ·X2·. Analog inputs (4 inputs in each connector).

10-pin male Phoenix minicombicon contact (3.5 mm pitch).

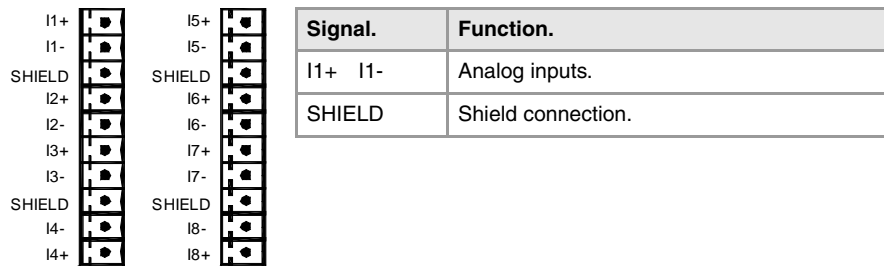

Each analog input has three pins (I+, I-, SH). Use shielded cables connecting their meshes to the corresponding shield pin.

Connector ·X1·. Analag outputs (4 outputs in each connector).

12-pin male Phoenix minicombicon contact (3.5 mm pitch).

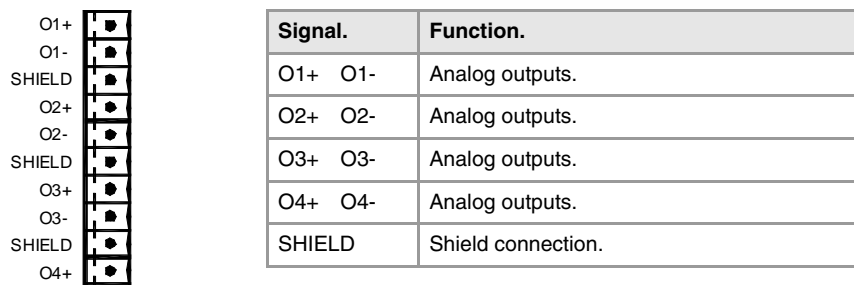

Each analog output has three pins (O+, O-, SH). Use shielded cables connecting their meshes to the corresponding shield pin.

10.

RIO70 REMOTE MODULES. (CANFAGOR PROTOCOL).

10.6 Feedback inputs (counter).

10.

RIO70 REMOTE MODULES. (CANFAGOR PROTOCOL).

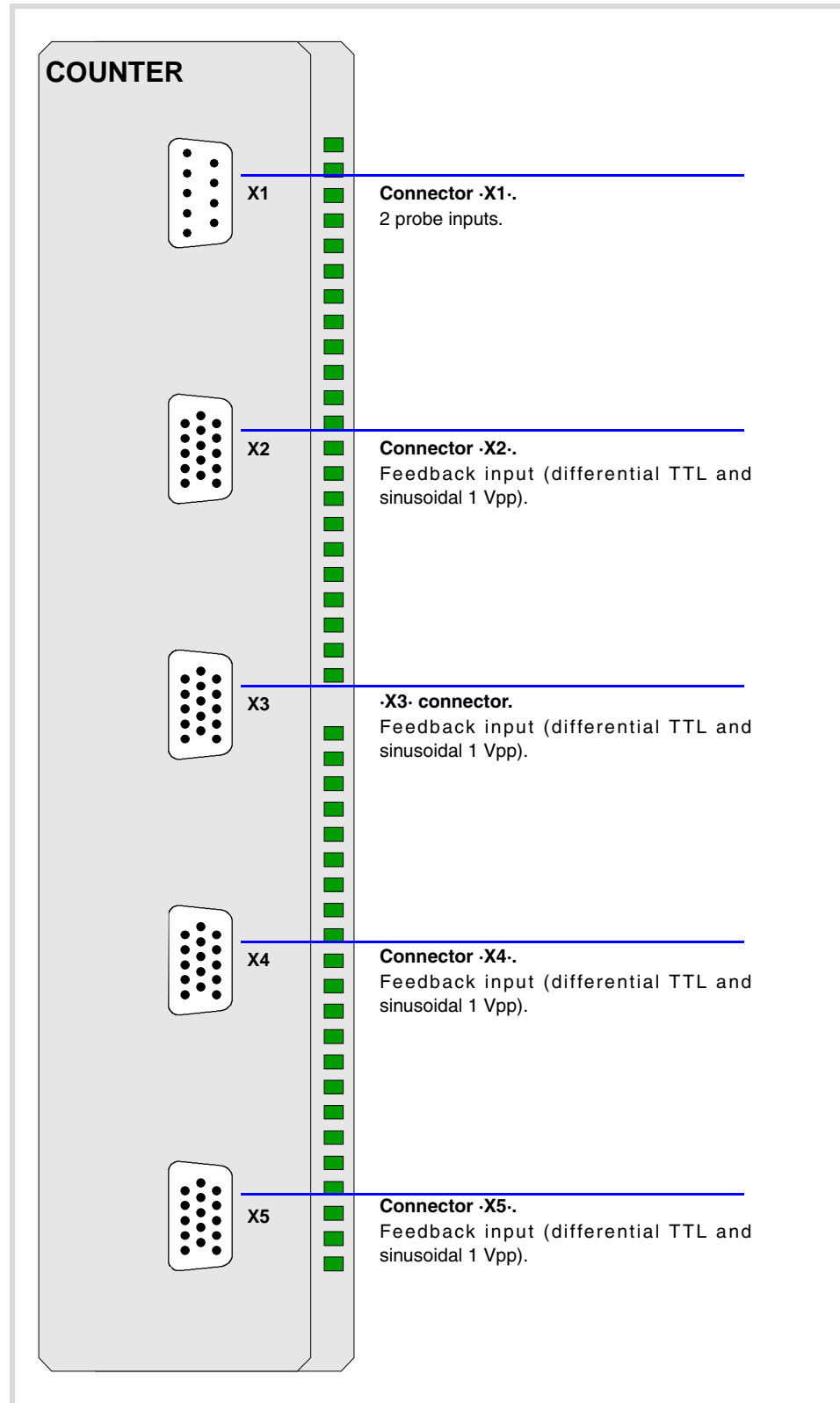

10.6.1 Elements (connectors).

Connector ·X1·.

Not being used from software version V01.10 on. Previous versions allowed connecting 2 probes of 5 V DC or 24 V DC.

Connectors ·X2· & ·X3· & ·X4· & ·X5·. Feedback inputs (differential TTL and sinusoidal 1 Vpp).

4 15-pin female SUB-D HD type connectors.

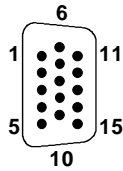

Pin.	Signal.	Function.
1	A	Feedback signals.
2	/ A	
3	B	
4	/ B	
5	I0	Reference signals.
6	/ I0	
7	AL	Feedback alarm.
8	/ AL	
9	+5 Vdc	Voltage supply for the feedback system.
10	- - -	
11	GND	0 V reference signal.
12	- - -	
13	- - -	
14	- - -	
15	Chassis(*)	Shield.

(*) Pin ·15· is offered for compatibility. We recommend to connect the cable shield to the connector housing at both ends.

To connect feedback devices with differential TTL or 1 Vpp sinusoidal signals. See "[10.8 Feedback inputs. Technical characteristics and connection.](#)" on page 117.

10.

RIO70 REMOTE MODULES. (CANFAGOR PROTOCOL).

10.7 Electrical characteristics of the inputs and outputs.

Digital inputs.

All digital inputs, 16 per module, have a status indicating LED and are galvanically protected with opto-couplers. The electrical characteristics of the inputs are:

Nominal voltage.	+24 V DC (between +18 V DC and +30 V DC).
High threshold "1".	Over +18 V DC.
Low threshold "0".	Under +9 V DC.
Typical consumption of each input.	5 mA.
Maximum consumption of each input.	7 mA.

Digital outputs.

All digital outputs, 16 per module, have a status indicating LED and are galvanically protected with opto-couplers. The electrical characteristics of the outputs are:

Nominal voltage.	+24 V DC (between +18 V DC and +30 V DC).
Output voltage.	2 V less than the supply voltage.
Maximum output current.	500 mA per output.

The digital output modules have an 8 A fuse inside for protection against over-voltage (over 33 V DC) and against reverse connection.

Analog inputs.

Use shielded cables connecting their meshes to the corresponding shield pin. All the analog inputs, 8 per module, have the following characteristics:

Voltage within range.	± 10 V.
Resolution.	12 bits.
Input impedance.	20 k Ω .
Maximum cable length (unshielded).	75 mm.

Analog outputs.

Use shielded cables connecting their meshes to the corresponding shield pin. All the analog outputs, 4 per module, have the following characteristics:

Command voltage within range.	± 10 V.
Resolution.	16 bits.
Minimum impedance of the connected device.	10 k Ω .
Maximum cable length (unshielded).	75 mm.

10.

RIO70 REMOTE MODULES. (CANFAGOR PROTOCOL).

10.8 Feedback inputs. Technical characteristics and connection.

The module has 4 feedback inputs, valid for differential TTL and sinusoidal 1 Vpp signals.

Technical characteristics of the feedback inputs.

Power consumption: +5 V 1 A (250 mA per axis)

Work levels for differential TTL signal.

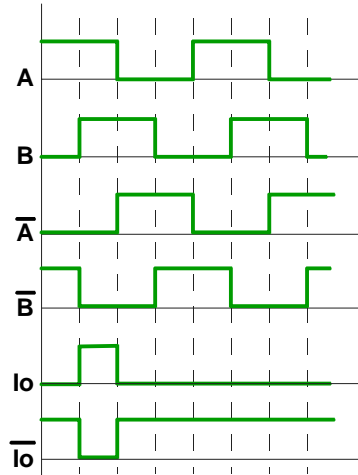

Maximum frequency:	1000 kHz.
Maximum gap between flanks:	460 ns.
Phase shift:	$90^\circ \pm 20^\circ$.
Maximum voltage in common mode:	± 7 V.
Maximum voltage in differential mode:	± 6 V.
Hysteresis:	0.2 V.
Maximum differential input current:	3 mA.

Work levels for sinusoidal 1 Vpp signal.

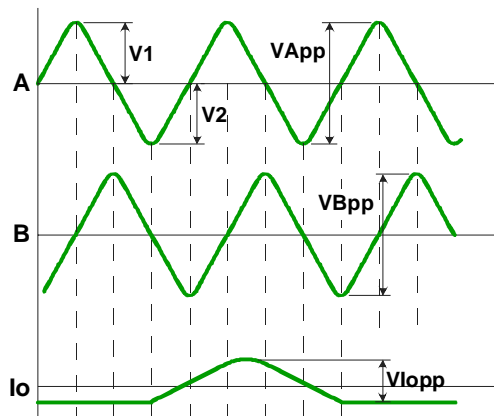

Maximum frequency:	500 kHz.
A and B signals. Amplitude:	$0.6 \div 1.2$ Vpp
A and B signals. Centered:	$ V1 - V2 / 2$ Vpp $\leq 6.5\%$
A and B signals. Ratio:	$VApp / VBpp = 0.8 \div 1.25$
A and B signals. Phase shift:	$90^\circ \pm 10^\circ$
Io signal. Amplitude:	$0.2 \div 0.85$ V
Io signal. Width:	$T - 90^\circ \leq I0 \leq T + 180^\circ$

10.

RIO70 REMOTE MODULES. (CANFAGOR PROTOCOL).

FAGOR 

CNC 8070

(REF: 1007)

Feedback cable characteristics.



Fagor Automation offers a wide range of cables and extension cables to connect the feedback systems to the CNC. Refer to our catalog for further information.

The cable used must have overall shield; the rest of the characteristics of the cable, as well as its length, will depend on the type of feedback device used. Refer to our catalog.

The shield of the cable being used must be connected to the connector housing at both ends. The unshielded portion of the wires of an unshielded cable cannot be longer than 75 mm.

We recommend to run the feedback cables as far away as possible from the power cables of the machine.

10.

RIO70 REMOTE MODULES. (CANFAGOR PROTOCOL).



CNC 8070

(REF: 1007)

10.9 Numbering of the digital inputs and outputs.

Use machine parameters to set the number of digital I/O modules connected to the same CAN bus. If these parameters are not set, the CNC numbers the modules automatically according to the order of the remote groups (-ADDRESS- selector of the power supply module).

Numbering according to the order of the remote groups.

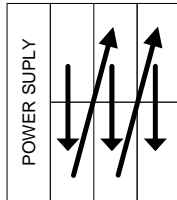

The CNC numbers the modules automatically according to the order of the remote groups (-ADDRESS- selector of the power supply module). Within each group, they are ordered from top to bottom and from left to right.

10.

RIO70 REMOTE MODULES. (CANFAGOR PROTOCOL).

Example of configuration of the following remote modules.

Group -1-	Group -2-	Group -3-
48 digital inputs.	16 digital inputs.	32 digital inputs.
32 digital outputs.	16 digital outputs.	16 digital outputs.

Example 1.

	Group -1- (address = 1)	Group -2- (address = 2)	Group -3- (address = 3)
Digital inputs.	1 .. 48	49 .. 64	65 .. 96
Digital outputs.	1 .. 32	33 .. 48	49 .. 64

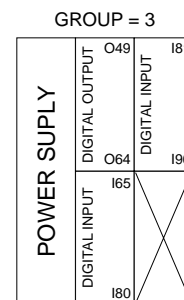
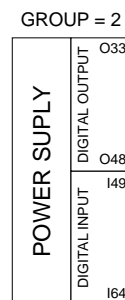
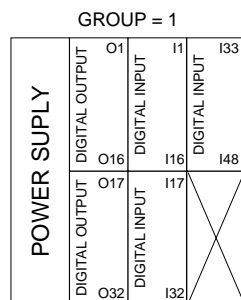

Example 2.

	Group -1- (address = 1)	Group -2- (address = 3)	Group -3- (address = 2)
Digital inputs.	1 .. 48	81 .. 96	49 .. 80
Digital outputs.	1 .. 32	49 .. 64	33 .. 48

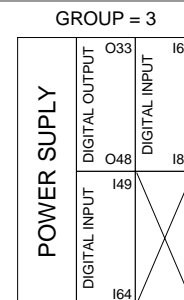
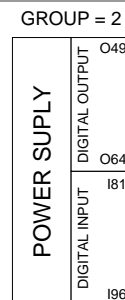
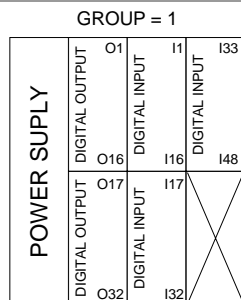

CNC 8070

(REF: 1007)

Numbering by machine parameters.

When the numbering is set by machine parameters, each module is assigned a base index and the inputs or outputs of that module are numbered after it. The values of the base index must be comply with the formula $16n+1$ (i.e. 1, 17, 33, etc.). The rest of the inputs or outputs are numbered sequentially. The base indexes may follow any order, they do not have to be sequential.

When inserting a new module, the first modules will be assigned the numbering of the table and the last one will be assigned the next valid base index after the highest one assigned until then.

10.

RIO70 REMOTE MODULES. (CANFAGOR PROTOCOL).

Examples for numbering the different modules.

GROUP = 1				GROUP = 2		
POWER SUPPLY	DIGITAL OUTPUT	O33	I1	POWER SUPPLY	DIGITAL OUTPUT	O49
	DIGITAL INPUT	I16	I112		DIGITAL OUTPUT	O64
	DIGITAL OUTPUT	O81	I33	DIGITAL INPUT	I113	
	DIGITAL INPUT	I48		DIGITAL INPUT	I128	

Remote group (1).

	Digital inputs.		Digital outputs.	
	Base index.	Numbering.	Base index.	Numbering.
Module 1.	1	1 .. 16	33	33 .. 48
Module 2.	33	33 .. 48	81	81 .. 96
Module 3.	97	97 .. 112		

Remote group (2).

	Digital inputs.		Digital outputs.	
	Base index.	Numbering.	Base index.	Numbering.
Module 1.	113	113 .. 128	49	49 .. 64

10.10 Numbering of the analog inputs and outputs and of the feedback inputs.

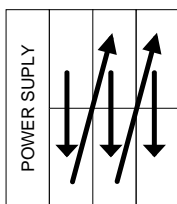

The CNC numbers the modules automatically according to the order of the remote groups (.ADDRESS. selector of the power supply module). Within each group, they are ordered from top to bottom and from left to right.

Group -1-
8 analog inputs.
4 analog inputs.

Group -2-
8 analog inputs.
4 analog inputs.

Example.

	Group -1- (address = 1)	Group -2- (address = 2)
Analog inputs.	1 .. 8	9 .. 16
Analog outputs.	1 .. 4	5 .. 8

10.

RIO70 REMOTE MODULES. (CANFAGOR PROTOCOL).



CNC 8070

(REF: 1007)

10.11 Probe connection.

The digital inputs let you handle the signal of the two 24 V DC probes . Use machine parameters to define which digital input is associated with each probe and their type of pulse.

Probe whose output has a normally open contact. Connection to +24 V.

The connection acts upon the up flank (positive pulse) of the probe signal.

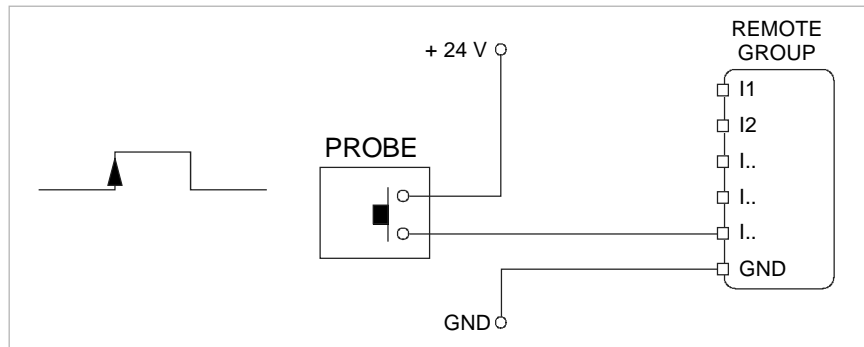

Probe whose output has a normally closed contact. Connection to +24 V.

The connection acts upon the up flank (positive pulse) of the probe signal.

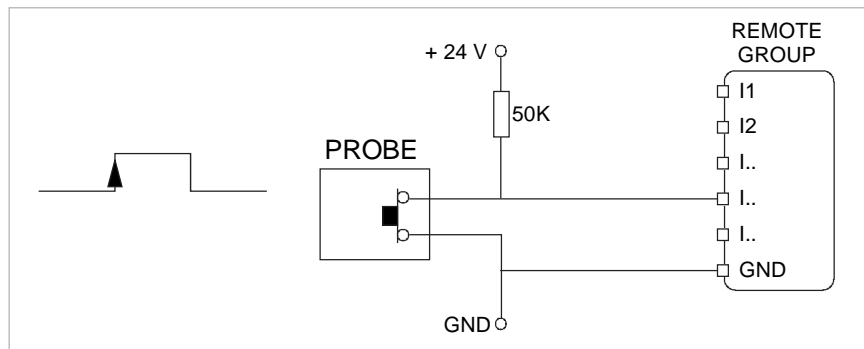

Interface with an open-collector output. Connection to +24 V.

The connection acts upon the down flank (negative pulse) of the probe signal.

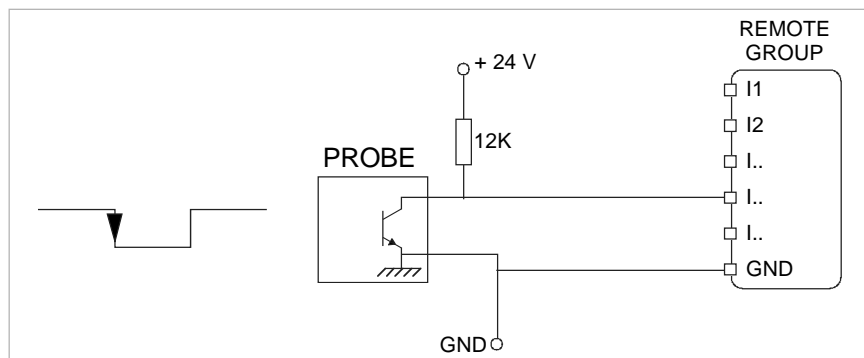

10.

RIO70 REMOTE MODULES. (CANFAGOR PROTOCOL).

Interface with a PUSH-PULL output. Connection to +24 V.

Depending on the interface being used, the connection acts upon the up flank or down flank of the probe signal.

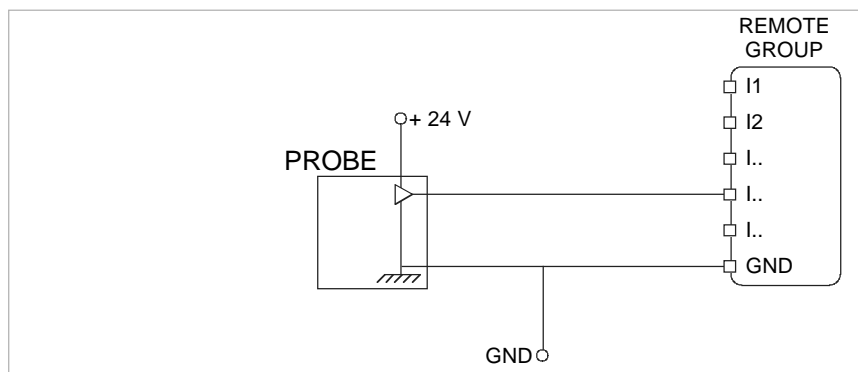

10.

RIO70 REMOTE MODULES. (CANFAGOR PROTOCOL).

11 RIO5 REMOTE MODULES. (CANOPEN PROTOCOL).

Remote modules may be used to have an additional number of digital and analog inputs and outputs (remote I/O) that, distributed at different points of the machine or mounted in the cabinet, permit controlling various devices of the machine. The remote modules are distributed by groups (nodes) and are connected to the central unit through the CAN bus that can have up to 32 nodes, including the central unit and the keyboards. The following elements may be available with RIO5 series modules.

Type of input/output	Amount.
Digital inputs.	1024
Digital outputs.	1024
General purpose analog inputs.	40
Analog outputs.	40
Analog inputs for temperature sensors.	10

When the CNC works with CANOpen bus, this bus lets combine in the bus groups (nodes) formed by RIO5 and RIOW series modules; modules of both series cannot be combined in the same group.

Fagor remote modules, RIO5 series, available for CAN bus with CANOpen protocol.

Each group (node) may consist of up to two of these modules.

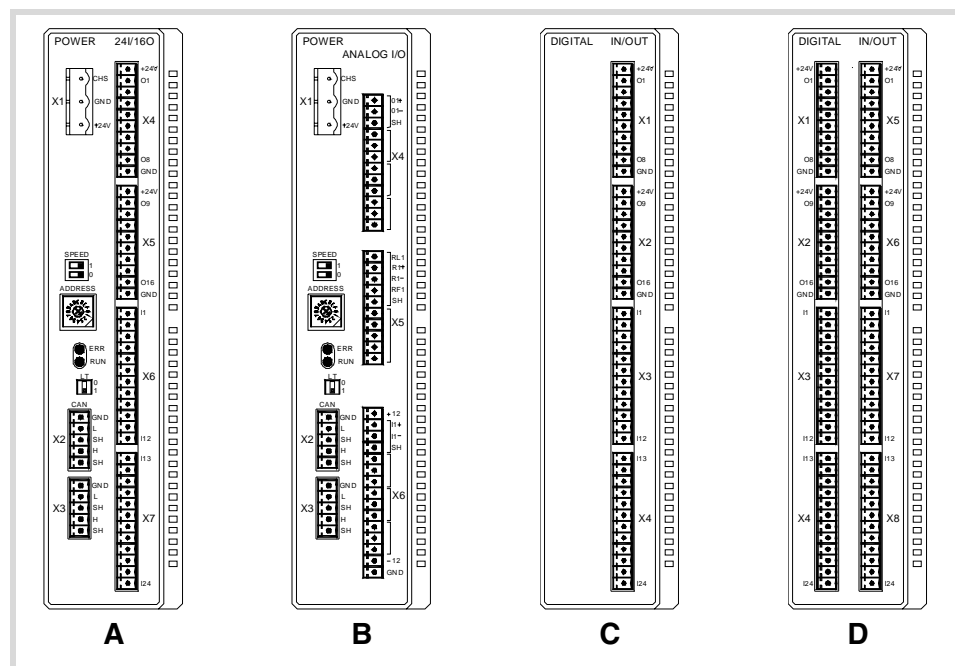

- A Power supply with 24 digital inputs and 16 digital outputs.
- B Power supply with 4 analog inputs, 4 analog outputs and 2 inputs for temperature sensors.
- C Digital Inputs / Outputs (single module). Each module has 24 digital inputs and 16 digital outputs.
- D Digital Inputs / Outputs (double module). Each module has 48 digital inputs and 32 digital outputs.

11.

RIO5 REMOTE MODULES. (CANOPEN PROTOCOL).



CNC 8070

(REF: 1007)

General considerations on power supply modules.

When mounting the groups, bear in mind the following.

- One of the power supply modules must be present in each group. The power supply must be powered at 24 Vdc and connected to the CAN bus of the system.
- Two power supply modules cannot be in the same group.
- Power supplies of both models may be connected to the same CAN bus.

Fagor modules and third-party modules. Considerations about the number of analog inputs.

The CANopen bus can manage up to 60 analog inputs of any kind. The maximum number of analog inputs of each type that the bus can have depends on the type of modules installed.

CAN bus with Fagor modules.

A bus made up of only with Fagor modules can have 40 general purpose analog inputs and 10 inputs for temperature sensors. In Fagor modules, the analog inputs are pre-assigned as general-purpose inputs (four per module) or as inputs for temperature sensors (two inputs per module).

In Fagor modules of analog inputs, the CNC considers the inputs for the temperature sensor (connector X5) as analog inputs. Therefore, when numbering the inputs, the CNC considers that each module has 6 analog inputs; the four analog inputs plus the two temperature sensor inputs.

CAN bus with third-party modules.

A bus made up of only third-party modules can have 60 analog inputs of any kind. In third-party modules, it is up to the manufacturer to set the right configuration so the CNC treats these analog inputs as general purpose, for temperature sensors, etc.

CAN bus with Fagor modules and third-party modules.

A bus made up of Fagor modules and third-party modules, each Fagor modules counts as 6 analog inputs; 4 general purpose inputs and 2 inputs for temperature sensors. The inputs of third-party modules can be of any kind.

In third-party modules, it is up to the manufacturer to set the right configuration so the CNC treats these analog inputs as general purpose, for temperature sensors, etc.

Consumption of the remote modules.

Each group consumes 1.2 A without including the consumption of the digital and analog outputs.

11.1 Dimensions and mounting of the modules.

Place the modules on 2 profiles, according to the UNE 50022 standard, with 2 securing ends, one at each end of the group; they help securing the modules besides maintaining the right gap between the profiles.

Dimensions of the modules.

Always leave a 140 mm gap under the modules for ventilation and later handling.

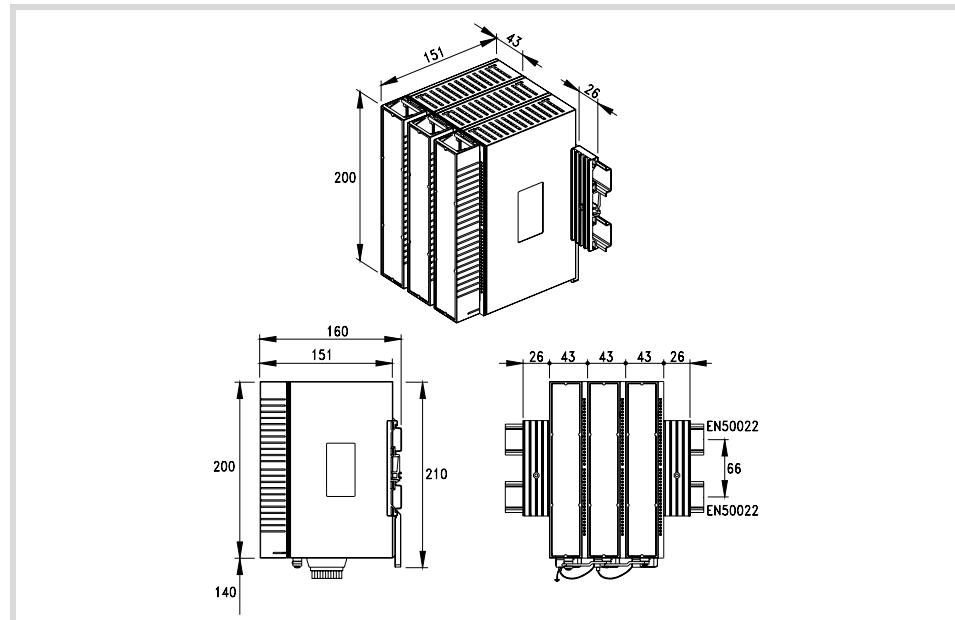

Connection of the modules.

The modules of the group are connected as follows:

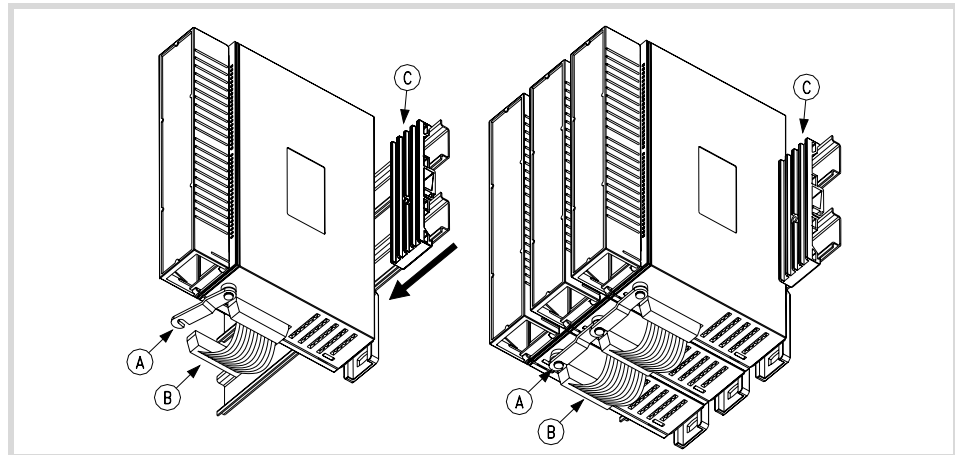

- A For ground connection.
- B Ribbon cable to interconnect the modules.
- C Securing ends.

Each group is connected to the system (CPU, Keyboard, etc.) through the CAN bus as described later on.



DO NOT make any connection or connect any module to the power supply while the latter is turned on. Before making any connection, ribbon cable included, turn the power supply off by unplugging the power cable.

11.

RIO5 REMOTE MODULES. (CANOPEN PROTOCOL).

FAGOR 

CNC 8070

(REF: 1007)

11.2 Power supply.

The power supply must be powered at 24 Vdc and connected to the CAN bus of the system. There are two power supply models.

- Power supply with 24 digital inputs and 16 digital outputs.
- Power supply with 4 analog inputs, 4 analog outputs and 2 inputs for temperature sensors.

Power supply with digital inputs and digital outputs.

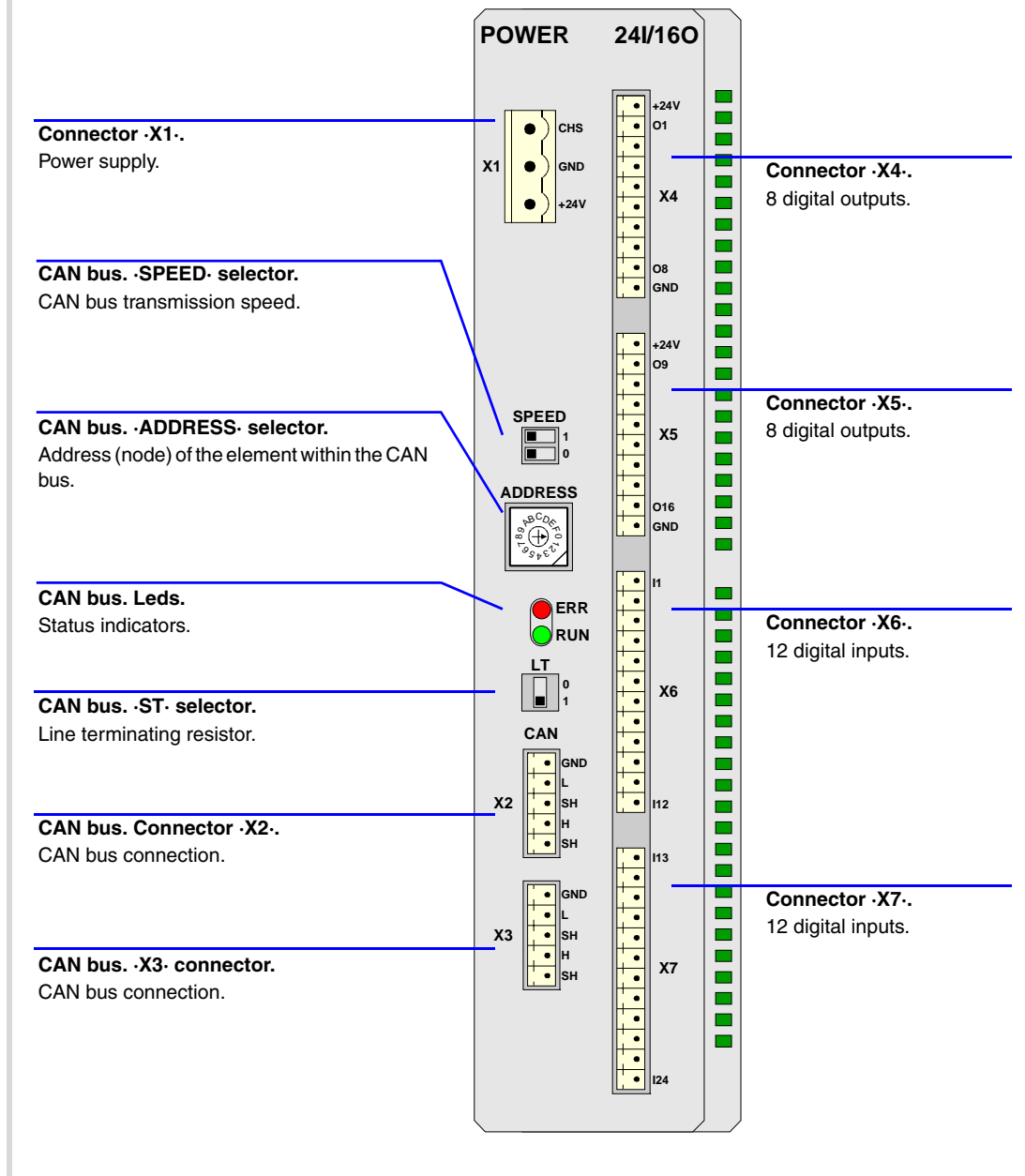

11.

RIO5 REMOTE MODULES. (CANOPEN PROTOCOL).



CNC 8070

(REF: 1007)

Power supply with analog inputs and outputs.

11.

RIO5 REMOTE MODULES. (CANOPEN PROTOCOL).

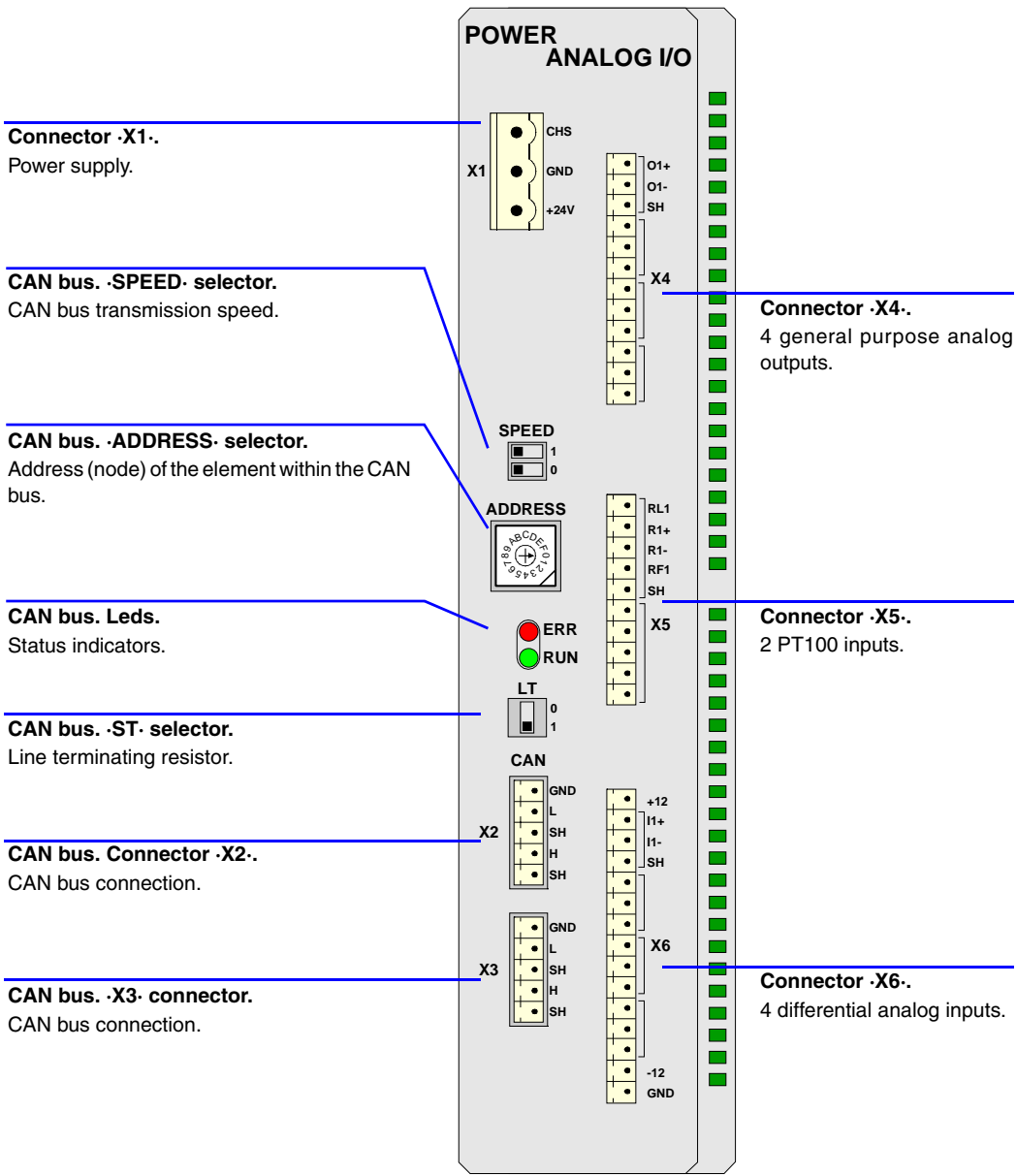

CNC 8070

(REF: 1007)

11.2.1 Elements (connectors).

Connectors at the power supply.

Connector ·X1·. Power supply.

3-pin male Phoenix combicom contact (7.62 mm pitch).

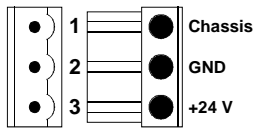

Signal.	Function.
Chassis	Shield.
GND	Power supply.
+24 V	Power supply.

CAN bus. ·CAN· connector. Connector ·X2· & ·X3·.

5-pin male Phoenix minicombicon contact (3.5 mm pitch).

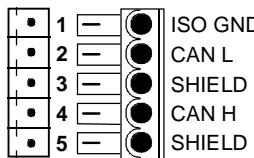

Pin.	Signal.	Function.
1	ISO GND	Ground / 0 V.
2	CAN L	(LOW) bus signal.
3	SHIELD	CAN shield.
4	CAN H	(HIGH) bus signal.
5	SHIELD	CAN shield.

For further information on how to configure the connection of the elements to the CAN bus, refer to chapter "14 Bus CAN (CANfagor/CANopen protocols)." of this manual.

CAN bus. ·SPEED· selector. Selecting the baudrate for the CANopen bus.

SPEED The transmission speed depends on the total length of the cable. Use the following approximate values. Assigning other values may cause communication errors due to signal distortion.



·CO BR·	Speed	Length of the CAN bus.
SPEED <input type="checkbox"/> 1 <input type="checkbox"/> 0	1000 kHz	Up to 20 meters.
SPEED <input type="checkbox"/> 1 <input checked="" type="checkbox"/> 0	800 kHz	From 20 to 40 meters.
SPEED <input checked="" type="checkbox"/> 1 <input type="checkbox"/> 0 SPEED <input type="checkbox"/> 1 <input checked="" type="checkbox"/> 0	500 kHz	From 40 to 100 meters. Unlike at the keyboards, the communication at 250 kHz is not available at the remote modules.

In order for any change of speed to be assumed, the corresponding module must be reset; however, we recommend to change the speed while the modules and the CNC are off.

CAN bus. ·ADDRESS· selector. Address (node) of the element within the bus.



Each one of the elements integrated into the CAN bus is identified by the 16-position rotary switch (0-15) "Address" (also referred to as "Node_Select").

The CNC must always occupy position "0" and the rest of the elements of the bus will occupy consecutive positions starting with 1. In order for any change at the "Address" switch to be assumed, the CNC must be restarted and the corresponding drive must be reset, however, we recommend to change the address while the modules and the CNC are off.

The "Address" switch also sets the priority of the group within the bus; the lower the number the higher the priority. We recommend the keyboard and jog panel to be the last node of the bus.

CAN bus. ·ST· selector.

LT Line terminating resistor. The ·LT· switch identifies which are the elements that occupy the ends of the CAN bus; i.e. the first and last physical element in the connection.



The switch position of the terminating elements must be "1" and that of the rest of the elements "0".

·ERROR· LED. Status indicator LED.

Red LED. Its meaning depends on the blinking speed.

Type of blinking.	Meaning.
LED off.	The module works properly.
Blinking fast.	Module configuration stage.
Single blinking.	Warning. Poor transmission.
Double blinking.	There is no communication with the cpu.
LED on.	Error. Too many errors.

CAN bus. Led ·RUN·.

The LED is green. Its meaning depends on the blinking speed.

Type of blinking.	Meaning.
LED on.	The module works properly.
Single blinking.	Module stopped.
Blinking fast.	Module configuration stage.
Continuous blinking.	Start-up stage or error.

Connectors for the digital inputs and outputs.

Connector ·X4· & ·X5·. Digital outputs (8 outputs in each connector).

10-pin male Phoenix minicombicon contact (3.5 mm pitch). Both connectors must be powered with 24 V DC and GND.

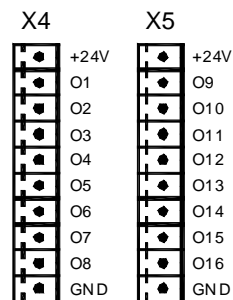

Signal.	Function.
+ 24 V	Power supply.
O1 - O8	Digital outputs.
O9 - O16	Digital outputs.
GND	Power supply.

Connector ·X6· & ·X7·. Digital inputs (12 inputs in each connector).

12-pin male Phoenix minicombicon contact (3.5 mm pitch).

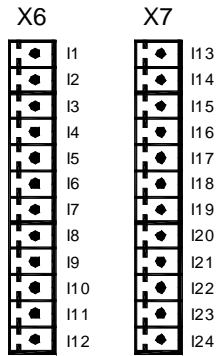

Signal.	Function.
I1 - I12	Digital inputs.
I13 - I24	Digital inputs.

11.

RIO5 REMOTE MODULES. (CANOPEN PROTOCOL).

Connectors for the analog inputs and outputs.

Connector ·X4·. General purpose analog outputs (4 outputs).

12-pin male Phoenix minicombicon contact (3.5 mm pitch).

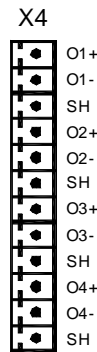

Signal.	Function.
O1+ O1-	Analog outputs.
O2+ O2-	Analog outputs.
O3+ O3-	Analog outputs.
O4+ O4-	Analog outputs.
SH	Shield connection.

Each analog output has three pins (O+, O-, SH). Use shielded cables connecting their meshes to the corresponding shield pin.

Connector ·X6·. Differential analog inputs (4 inputs).

15-pin male Phoenix minicombicon contact (3.5 mm pitch).

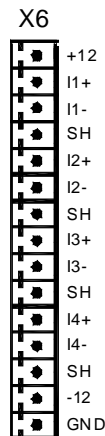

Signal.	Function.
I1+ I1-	Analog inputs.
I2+ I2-	Analog inputs.
I3+ I3-	Analog inputs.
I4+ I4-	Analog inputs.
SH	Shield connection.
+12 -12	12 V output.
GND	0 V reference signal.

Each analog input has three pins (I+, I-, SH). Use shielded cables connecting their meshes to the corresponding shield pin.



CNC 8070

(REF: 1007)

Connectors for the temperature sensors PT100.**Connector ·X5·. Inputs for temperature sensors PT100 (2 inputs).**

10-pin male Phoenix minicombicon contact (3.5 mm pitch).

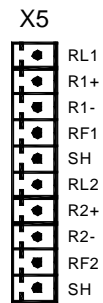

Signal.	Function.
R1+ R1- RL1 RF1	Signals of the PT100 sensor.
R2+ R2- RL2 RF2	Signals of the PT100 sensor.
SH	Shield connection.

Each input has 5 pins (RL, R+, R-, RF, SH). Use shielded cables connecting their meshes to the corresponding shield pin.

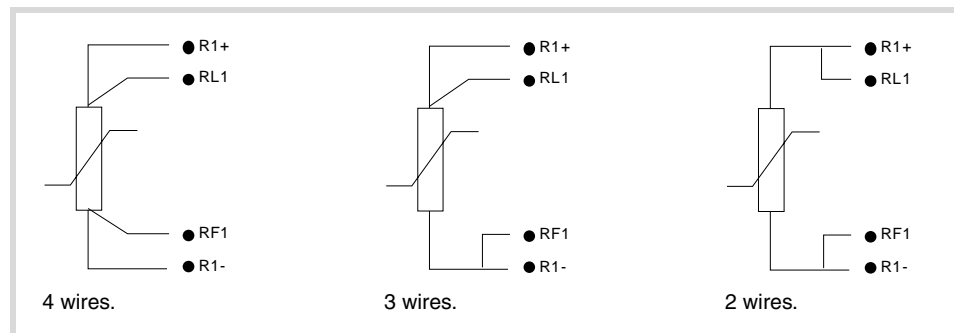
**11.**

RIO5 REMOTE MODULES. (CANOPEN PROTOCOL).

11.3 Digital inputs and digital outputs (single module).

This module is used to expand the digital inputs and outputs (remote I/O). Each module has 24 digital inputs and 16 digital outputs.

**Digital inputs and digital outputs
(single module).**

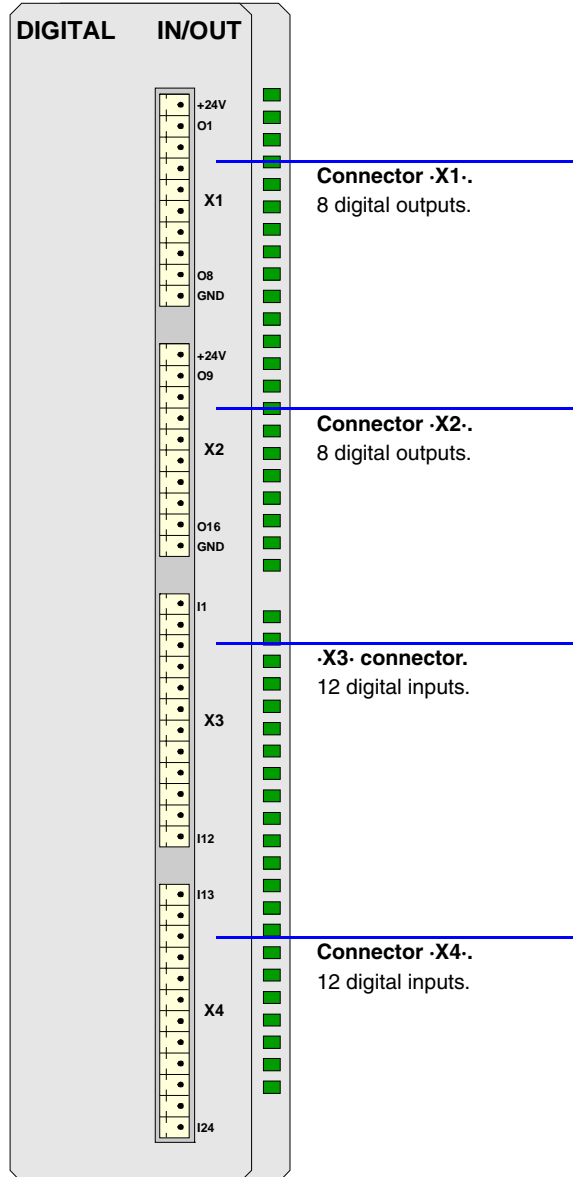

11.

RIOS REMOTE MODULES. (CANOPEN PROTOCOL).

11.3.1 Elements (connectors).

Connector ·X1· & ·X2·. Digital outputs (8 outputs in each connector).

10-pin male Phoenix minicombicon contact (3.5 mm pitch). Both connectors must be powered with 24 V DC and GND.

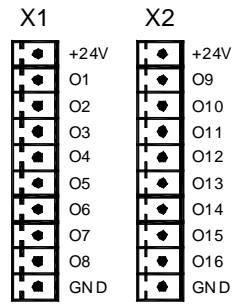

Signal.	Function.
+ 24 V	Power supply.
O1 - O8	Digital outputs.
O9 - O16	Digital outputs.
GND	Power supply.

Connector ·X3· & ·X4·. Digital inputs (12 inputs in each connector).

12-pin male Phoenix minicombicon contact (3.5 mm pitch).

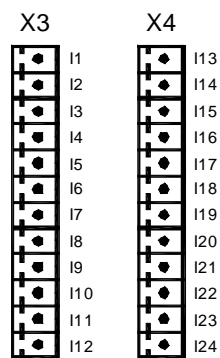

Signal.	Function.
I1 - I12	Digital inputs.
I13 - I24	Digital inputs.

11.

RIO5 REMOTE MODULES. (CANOPEN PROTOCOL).

11.4 Digital inputs and digital outputs (double module).

This module is used to expand the digital inputs and outputs (remote I/O). Each module has 48 digital inputs and 32 digital outputs.

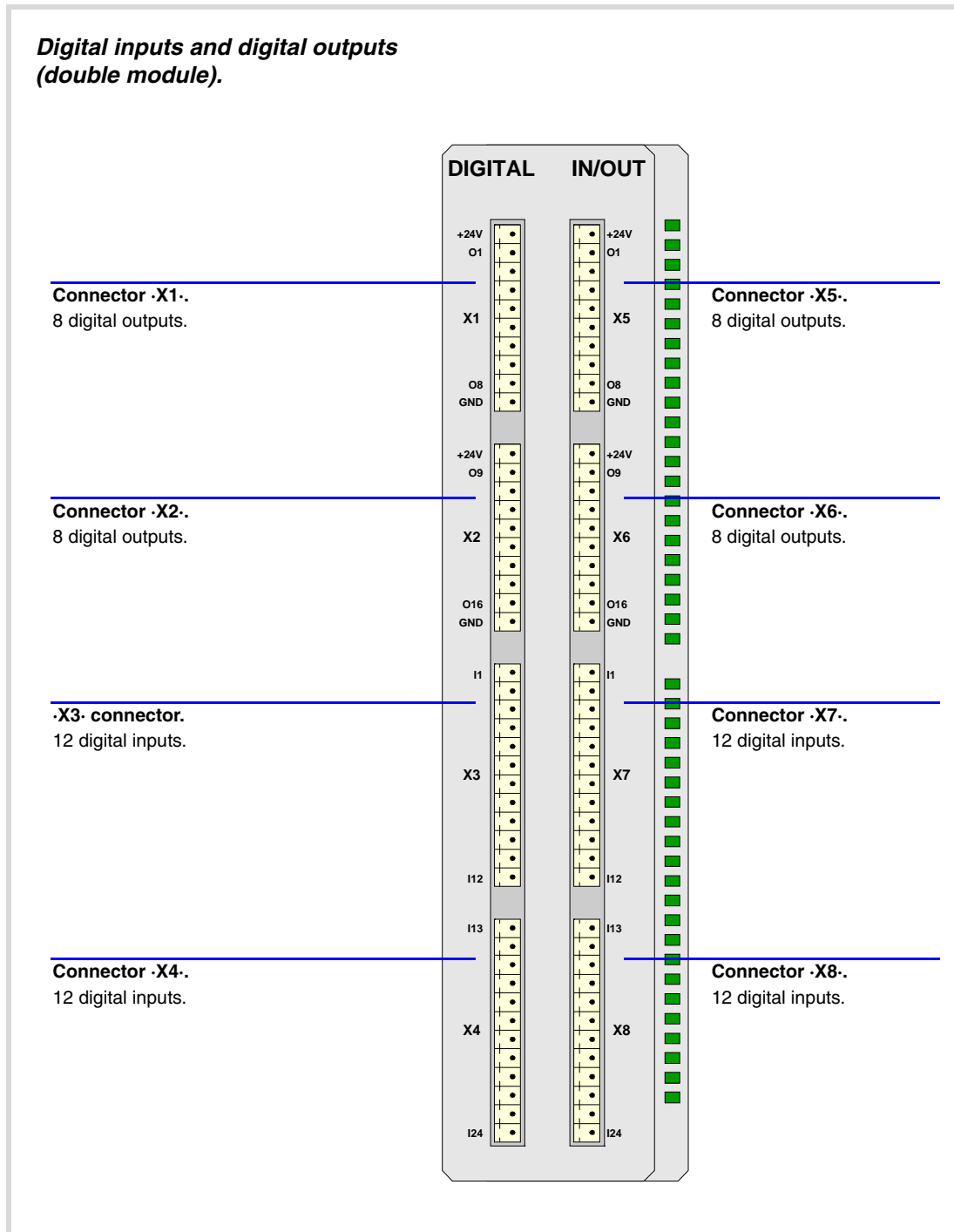

11.

RIO5 REMOTE MODULES. (CANOPEN PROTOCOL).



CNC 8070

(REF: 1007)

11.4.1 Elements (connectors).

Connector ·X1· & ·X2· & ·X5· & ·X6·. Digital outputs (8 outputs in each connector).

10-pin male Phoenix minicombicon contact (3.5 mm pitch). Both connectors must be powered with 24 V DC and GND.

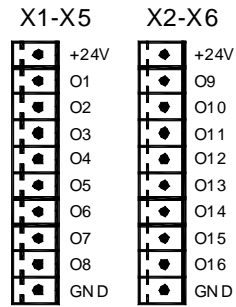

Signal.	Function.
+ 24 V	Power supply.
O1 - O8	Digital outputs.
O9 - O16	Digital outputs.
GND	Power supply.

Connector ·X3· & ·X4· & ·X7· & ·X8·. Digital inputs (12 inputs in each connector).

12-pin male Phoenix minicombicon contact (3.5 mm pitch).

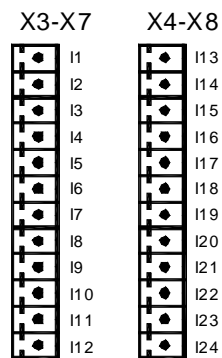

Signal.	Function.
I1 - I12	Digital inputs.
I13 - I24	Digital inputs.

11.

RIO5 REMOTE MODULES. (CANOPEN PROTOCOL).

11.5 Electrical characteristics of the inputs and outputs.

Digital inputs.

All digital inputs are galvanically isolated through opto-couplers. All the digital inputs have the following characteristics:

Nominal voltage.	+24 V DC (between +18 V DC and +30 V DC).
High threshold "1".	Over +18 V DC.
Low threshold "0".	Under +9 V DC.
Typical consumption of each input.	5 mA.
Maximum consumption of each input.	7 mA.

Digital outputs.

All digital outputs are galvanically isolated through opto-couplers. All the digital outputs have the following characteristics:

Nominal voltage.	+24 V DC (between +18 V DC and +30 V DC).
Output voltage.	2 V less than the supply voltage.
Maximum output current.	500 mA per output.

The digital outputs have a fuse inside for protection against over-voltage (over 33 V DC) and against reverse connection of the power supply.

Analog inputs.

Use shielded cables connecting their meshes to the corresponding shield pin. All the analog inputs have the following characteristics:

Voltage within range.	± 10 V.
Resolution.	12 bits.
Input impedance.	20 k Ω .
Maximum cable length (unshielded).	75 mm.

Analog outputs.

Use shielded cables connecting their meshes to the corresponding shield pin. All the analog outputs have the following characteristics:

Command voltage within range.	± 10 V.
Resolution.	16 bits.
Minimum impedance of the connected device.	10 k Ω .
Maximum cable length (unshielded).	75 mm.

Inputs for the temperature sensors PT100.

Use shielded cables connecting their meshes to the corresponding shield pin. The electrical characteristics of the inputs are:

Type of sensor.	PT100
Temperature range.	Between -200 °C (-328 °F) and +850 °C (1562 °F).

11.

RIO5 REMOTE MODULES. (CANOPEN PROTOCOL).

FAGOR 

CNC 8070

(REF: 1007)

Resolution.	0.1 °C
Typical consumption of each input.	2 mA.
Maximum cable length (unshielded).	75 mm.

11.**RI05 REMOTE MODULES. (CANOPEN PROTOCOL).****CNC 8070**

(REF: 1007)

11.6 Numbering of the digital inputs and outputs.

Use machine parameters to set the number of digital I/O modules connected to the same CAN bus. If these parameters are not set, the CNC numbers the modules automatically according to the order of the remote groups (-ADDRESS- selector of the power supply module).

Numbering according to the order of the remote groups.

The CNC numbers the modules automatically according to the order of the remote groups (-ADDRESS- selector of the power supply module). Within each group, they are ordered from left to right.

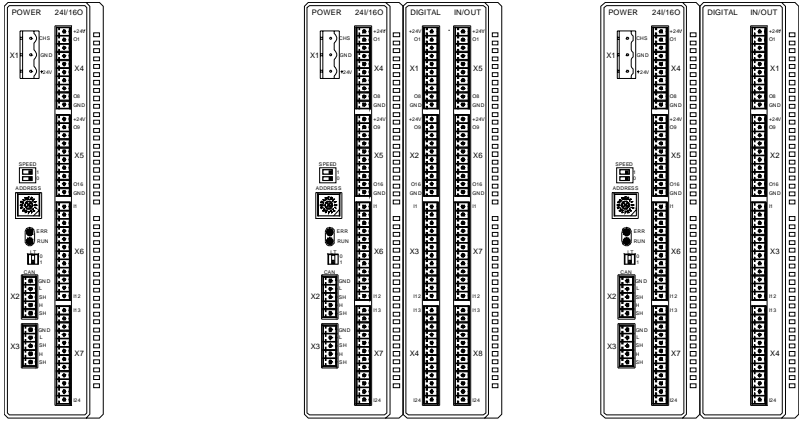

Group -1-	Group -2-	Group -3-
24 digital inputs.	24 + 48 digital inputs.	24 + 24 digital inputs.
16 digital outputs.	16 + 32 digital outputs.	16 + 16 digital outputs.

Example 1.

	Group -1- (address = 1)	Group -2- (address = 2)	Group -3- (address = 3)
Digital inputs.	1 .. 24	25 .. 48 49 .. 96	97 .. 120 121 .. 144
Digital outputs.	1 .. 16	17 .. 32 33 .. 64	65 .. 80 81 .. 96

Example 2.

	Group -1- (address = 1)	Group -2- (address = 3)	Group -3- (address = 2)
Digital inputs.	1 .. 24	73 .. 96 97 .. 144	25 .. 48 49 .. 72
Digital outputs.	1 .. 16	49 .. 64 65 .. 96	17 .. 32 33 .. 48

11.

RIO5 REMOTE MODULES. (CANOPEN PROTOCOL).

Numbering by machine parameters.

When the numbering is set by machine parameters, each module is assigned a base index and the inputs or outputs of that module are numbered after it. The double input/output module must be assigned two base indexes for the inputs and two base indexes for the outputs; one for each board;

The values of the base index must comply with the formula " $8n + 1$ " (i.e. 1, 9, 17, 25, etc.). The rest of the inputs or outputs are numbered sequentially. The base indexes may follow any order, they do not have to be sequential.

When inserting a new module, the first modules will be assigned the numbering of the table and the last one will be assigned the next valid base index after the highest one assigned until then.

Examples for numbering the different modules.

(*) For each base index, indicate the connector and the input or output it corresponds to.

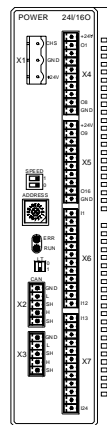

Power supply.

	Base index*	Numbering.
Digital inputs.	·1· (I1 of X6)	1 .. 24
Digital outputs.	·1· (I1 of X4)	1 .. 16

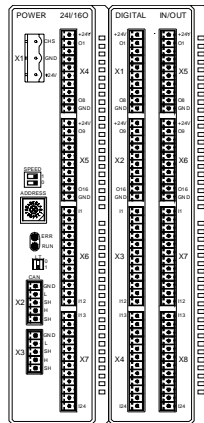

Power supply.

	Base index*	Numbering.
Digital inputs.	·1· (I1 of X6)	1 .. 24
Digital outputs.	·1· (I1 of X4)	1 .. 16

Module of digital inputs and outputs (double module).

	Base index*	Numbering.
Digital inputs.	·25· (I1 of X3) ·49· (I1 of X7)	25 .. 48 49 .. 64
Digital outputs.	·17· (I1 of X1) ·33· (I1 of X5)	17 .. 32 33 .. 48

11.

RIO5 REMOTE MODULES. (CANOPEN PROTOCOL).

11.7 Numbering of the analog inputs and outputs and of the temperature sensor inputs.

The CNC numbers the modules automatically according to the order of the remote groups (.ADDRESS- selector of the power supply module).

When numbering the analog inputs, the CNC considers the inputs for the temperature sensor (connector X5) as analog inputs. Therefore, when numbering the inputs, the CNC considers that each module has 6 analog inputs; the four analog inputs plus the two temperature sensor inputs.

Group -1-
4 analog inputs.
4 analog inputs.
2 PT100 inputs

Group -2-
4 analog inputs.
4 analog inputs.
2 PT100 inputs

Example.

	Group -1- (address = 1)	Group -2- (address = 2)
Analog inputs.	1 .. 4	7 .. 10
PT100 inputs.	5 .. 6	11 .. 12
Analog outputs.	1 .. 4	5 .. 8

The CNC machine parameters must be set to indicate the number of PT100 inputs and to which analog inputs they are connected. A PT100 input is active if it has one of these temperature sensors connected to it. Refer to the installation manual for further detail.

11.

RIOS REMOTE MODULES. (CANOPEN PROTOCOL).

12 RIOW REMOTE MODULES. (CANOPEN PROTOCOL).

Remote modules may be used to have an additional number of digital and analog inputs and outputs (remote I/O) that, distributed at different points of the machine or mounted in the cabinet, permit controlling various devices of the machine. The remote modules are distributed by groups (nodes) and are connected to the central unit through the CAN bus that can have up to 32 nodes, including the central unit and the keyboards. The following elements may be available with RIOW series modules.

Type of input/output	Amount.
Digital inputs.	1024
Digital outputs.	1024
General purpose analog inputs.	40
Analog outputs.	40
Analog inputs for temperature sensors.	10

When the CNC works with CANopen bus, this bus lets combine in the bus groups (nodes) formed by RIO5 and RIOW series modules; modules of both series cannot be combined in the same group.

Fagor remote modules, RIOW series, available for CAN bus with CANopen protocol.

Each group (node) will consist of a leading (first) module (RIOW-CANOPEN-ECO / RIOW-CANOPEN-STAND), an end module (last) (RIOW-END) and a maximum of 64 intermediate modules for processing digital and analog inputs and outputs, etc.

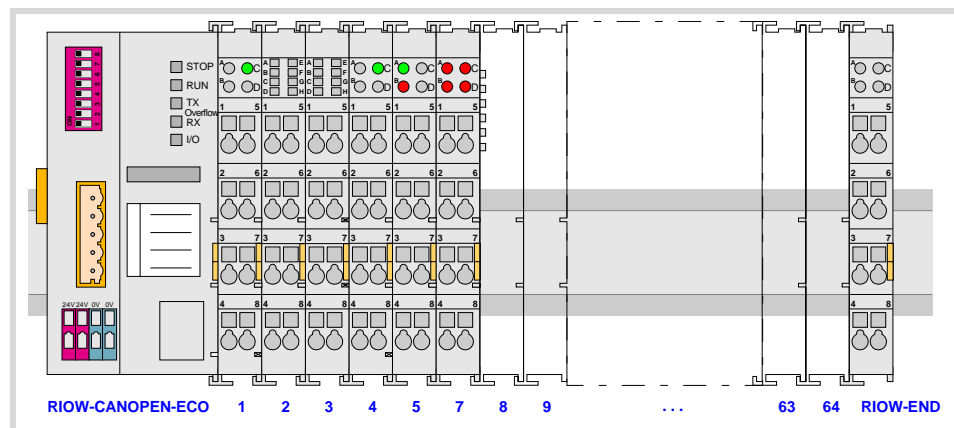

Module.	Description.
RIOW-CANOPEN-ECO. RIOW-CANOPEN-STAND.	This module must be the first module of each group and it is in charge of managing the internal bus of the group and connecting the group to the CAN bus of the system.
RIOW-END.	This module must be the last module of each group and it is used to end the internal bus of the group and ensure proper data flow.
RIOW-PS24.	Power supply module. This module is in charge of supplying power to the I/O modules through the side jumpers with 24 V 10 A.
RIOW-8DI.	Expansion module with eight 24 V DC digital inputs.
RIOW-8DO.	Expansion module with eight 24 V DC 0.5 A digital outputs.
RIOW-4AI.	Expansion module with four ± 10 V DC analog inputs.
RIOW-4AO.	Expansion module with four ± 10 V DC analog outputs.
RIOW-2AI-PT100.	Expansion module with 2 analog inputs for PT100 temperature sensors.

12.

RIOW REMOTE MODULES. (CANOPEN PROTOCOL).



CNC 8070

(REF: 1007)

12.1 Dimensions of the modules.

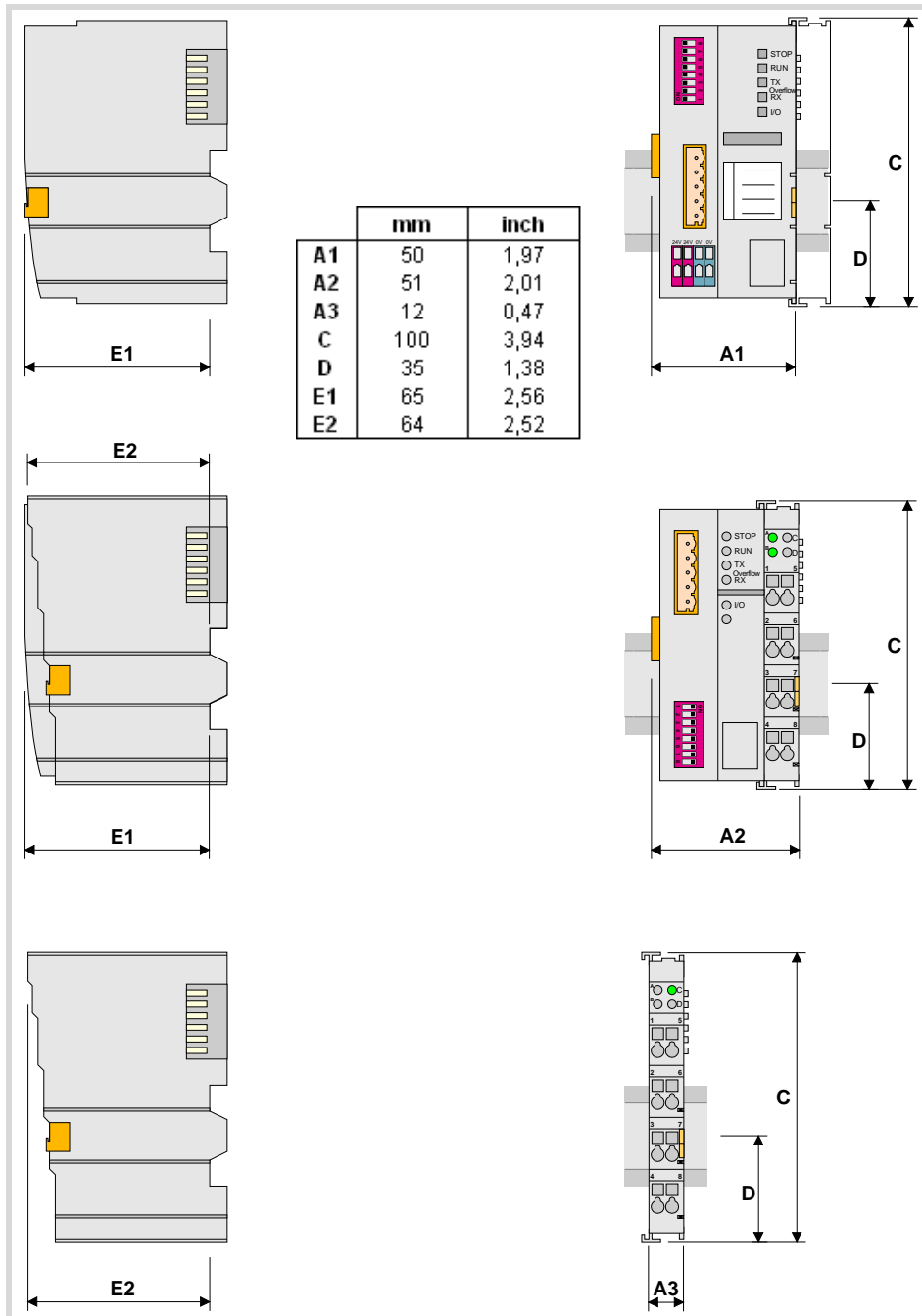

12.

RIOW REMOTE MODULES. (CANOPEN PROTOCOL).

12.2 Technical and electrical characteristics.

12.2.1 Technical characteristics.

Mechanical characteristics.

Vibrations (module RIOW-CANOPEN-ECO).

- Meets the IEC60068-2-6 standard.
- Sweep sine trial with a frequency step of 1 octave/minute ($\pm 10\%$) and 10 sweeps long per axis, on each of the three vertical axes.
 - 10 Hz \leq f < 57 Hz Constant movement with an amplitude of 0.075 mm.
 - 57 Hz \leq f < 150 Hz Constant 1g acceleration.

Vibrations (module RIOW-CANOPEN-STAND).

- Meets the IEC60068-2-6 standard.
- Sweep sine trial with a frequency step of 1 octave/minute ($\pm 10\%$) and on each of the three axes.
 - 5 Hz \leq f < 9 Hz 1.750 mm amplitude (constant) or 3.5 mm (short periods).
 - 9 Hz \leq f < 150 Hz 0.5 mm (constant acceleration) or 1g (short periods).

Choques.

- Meets the IEC60068-2-27 standard.
- Semi-sinusoidal pulses with 15g peaks for 11 ms. 3 pulses in each direction (positive and negative) of each of the three vertical axes (18 pulses in all).

Free fall.

- Meets the IEC60068-2-32 standard.
- Up to 1 m with the unit in its original packaging.

Electromagnetic compatibility.

Regulations valid for all RIOW modules.

Immunity against disturbances (regulation EN 50082-2:1996).

- Meets the EN 61000-4-2 regulation.
- Meets the EN 61000-4-3 regulation.
- Meets the EN 61000-4-4 regulation.
- Meets the EN 61000-4-6 regulation.

Regulations valid for all RIOW modules except for RIOW-CANOPEN-ECO and RIOW-CANOPEN-STAND modules.

Emission of disturbances (regulation EN 50081-1:1993).

- Meets the EN 55022 regulation.

Regulations only valid for all RIOW-CANOPEN-ECO and RIOW-CANOPEN-STAND modules.

Emission of disturbances (regulation EN 50081-2:1994).

- Meets the EN 55011 regulation.

12.

RIOW REMOTE MODULES. (CANOPEN PROTOCOL).



CNC 8070

(REF: 1007)

Ambient conditions.

- Relative humidity: 5-95% without condensation.
- Work temperature: 0-55 °C.
- Storage temperature: Between -20 °C (77 °F) and +85 °C (158 °F).
- Resistance to harmful substances: Meets standards IEC 60068-2-42 and IEC 60068-2-43.

Degree of protection.

- It meets the protection standard IP 20.

The machine manufacturer must comply with the EN 60204-1 (IEC-204-1) regulation regarding electrical shocks in case of defective input/output pins with external power supply when not plugging the connector before turning the power supply on.



Do not get into the inside of the unit. This unit MUST NOT be opened by unauthorized personnel. Only personnel authorized by Fagor Automation may manipulate the inside of this unit.

12.

RIOW REMOTE MODULES. (CANOPEN PROTOCOL).

FAGOR

CNC 8070

(REF: 1007)

12.2.2 Electrical characteristics of the inputs and outputs.

Digital outputs.

All digital outputs have a status indicating LED that turns on when the output is active. The outputs are protected with opto-couplers and protected against short-circuits.

Technical characteristics.	
Number of outputs.	8 outputs per module.
Nominal voltage.	+24 V DC (between -15 % and +20 %).
Typical consumption.	15 mA per module plus the consumption of the elements.
Output current.	500 mA per output.

Digital inputs.

All digital inputs have a status indicating LED that turns on when the input is active. The inputs are protected by opto-couplers.

Technical characteristics.	
Number of inputs.	8 inputs per module.
Nominal voltage.	+24 V DC (between -15 % and +20 %).
Low threshold "0".	Within -3 and 5 V DC.
High threshold "1".	Within 15 and 30 V DC.
Typical consumption.	2.8 mA.

Analog inputs.

All analog inputs have a status indicating LED that turns on when there is an over-voltage or an under-voltage.

Use shielded cables connecting their meshes to the corresponding shield pin. Maximum cable length (unshielded): 75 mm.

Technical characteristics.	
Number of inputs.	4 inputs per module.
Voltage range.	± 10 V.
Maximum input voltage.	± 40 V.
Typical input impedance.	> 100 k Ω
Measuring error (25 °C).	$< \pm 0.1$ %
Resolution.	12 bits.
Typical consumption of each input.	0.5 mA.

Analog outputs.

Each input has 2 LED's; a green one that turns on when the bus transmission is OK and a red one that turns on when there is an overload or a short-circuit to ground at any of the outputs.

Use shielded cables connecting their meshes to the corresponding shield pin. Maximum cable length (unshielded): 75 mm.

Technical characteristics.	
Number of outputs.	4 outputs per module.
Voltage range.	± 10 V.
Impedance of the connected device.	> 5 k Ω
Output filter time (typical value).	100 ms.
Measuring error (25 °C).	$< \pm 0.1$ %
Resolution.	12 bits.
Typical consumption of each input.	0.5 mA.

12.

RIOW REMOTE MODULES. (CANOPEN PROTOCOL).



CNC 8070

(REF: 1007)

Analog inputs for PT100 temperature sensors.

Each input has 2 LED's; a green one that turns on when the bus transmission is OK and a red one that turns on when there is a reading error at the inputs.

The inputs are protected by opto-couplers. Use shielded cables connecting their meshes to the corresponding shield pin. Maximum cable length (unshielded): 75 mm.

Technical characteristics.	
Number of inputs.	2 inputs per module.
Type of sensor.	PT100
Type of connection.	2-wire or 3-wire interface.
Temperature range.	Between -200 °C (-328 °F) and +850 °C (1562 °F).
Resolution.	0.1 °C
Measuring error (25 °C).	<± 0.2 %
Response time, from when the sensor is connected until the first correct measure is obtained.	4 s.
Typical consumption of each input.	0.5 mA.

12.

RIOUW REMOTE MODULES. (CANOPEN PROTOCOL).

12.3 Sizing of the remote groups.

Maximum number of modules in a group.

Each group (node) will consist of a leading (first) module, an end module (last) and a maximum of 64 intermediate modules; power supply modules, input modules, output modules, etc. In any case, a group without leading (first) module and with last module cannot be wider than 780 mm.

Module.	Width.	Maximum quantity.
Leading (first) module. <ul style="list-style-type: none"> • RIOW-CANOPEN-ECO. • RIOW-CANOPEN-STAND. 	50 mm 51 mm	1
Intermediate modules. <ul style="list-style-type: none"> • RIOW-PS24. Power supply module. • RIOW-8DI. Module of 8 digital inputs. • RIOW-8DO. Module of 8 digital outputs. • RIOW-4AI. Module of 4 analog inputs. • RIOW-4AO. Module of 4 analog outputs. • RIOW-2AI-PT100. Module of 2 inputs for PT100 sensors. 	12 mm	64
Last Module. <ul style="list-style-type: none"> • RIOW-END. 	12 mm	1

Sizing of the group depending on the consumption at the bus.

The leading module is in charge of managing and feeding the internal bus of the group.

- The RIOW-CANOPEN-ECO module supplies a voltage of 5 V DC 1 A. This module consumes 350 mA at 5 V; therefore, it can supply a maximum of 650 mA to the rest of the modules.
- The RIOW-CANOPEN-STAND module supplies a voltage of 5 V DC 2 A. This module consumes 350 mA at 5 V; therefore, it can supply a maximum of 1650 mA to the rest of the modules.

If when configuring the remote group, the consumption at the bus exceeds the maximum value that the leading module can supply, duplicate the group.

Module.	Internal consumption of the module.
RIOW-CANOPEN-ECO.	350 mA.
RIOW-CANOPEN-STAND.	350 mA.
RIOW-END.	0 mA.
RIOW-PS24.	0 mA.
RIOW-8DI.	17 mA.
RIOW-8DO.	25 mA.
RIOW-4AI.	65 mA.
RIOW-4AO.	125 mA.
RIOW-2AI-PT100.	80 mA.

12.

RIOW REMOTE MODULES. (CANOPEN PROTOCOL).



CNC 8070

(REF: 1007)

Example: In a group made up of 1 RIOW-CANOPEN-ECO module, 5 RIOW-8DI modules and 10 RIOW-8DO modules, the total consumption will be 685 mA.

RIOW-CANOPEN-ECO.	350 mA.
RIOW-PS24.	0 mA.
RIOW-8DI.	5 x 17 mA
RIOW-8DO.	10 x 25 mA
RIOW-END.	0 mA.

12.

RIOW REMOTE MODULES. (CANOPEN PROTOCOL).



CNC 8070

(REF: 1007)

12.4 Installation of the modules.



DO NOT make any connection or connect any module or cable if the group is under power. Before making any connection, disconnect the power supply cable of the leading (first) module (RIOW-CANOPEN) and, if necessary, that of the power supply module (RIOW-PS24).

Place the modules on 1 profile, according to the European regulation EN50022 (DIN 35), with 2 securing ends, one at each end of the group to help secure the modules. RIOW series modules may be mounted horizontally or vertically; when mounting them vertically, use additional mounting blocks at the bottom to secure the modules.

12.

RIOW REMOTE MODULES. (CANOPEN PROTOCOL).

Ground connection.

The profiles on which the modules are mounted must be connected to the system ground because some modules make contact with the profile to connect to ground. To connect the profiles to ground, use a cable with a minimum section of 4 mm². To ensure contact between the profile and the modules, the material of the profile must not be corrosive.

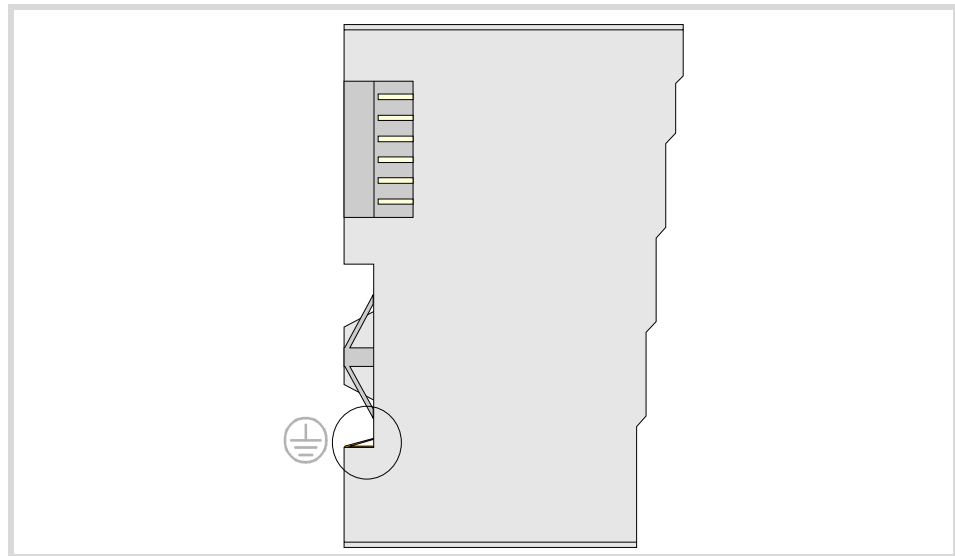

At the RIOW-PS24 module, the ground connection is done through the bottom pins of the module. The ground connection is extended to the adjacent modules through the side jumpers of the module.

Shield connection.

Proper shielding of the signal and data cables reduces interference and improves signal quality while preventing measuring and data transmission errors. The cables must be continuously shielded to ensure compliance with the technical specifications related to measuring accuracy.

Ambient characteristics of the enclosure.

The temperature of the cabinet (enclosure) where the modules are mounted must not exceed 55 °C (131°F) when the modules are working. The heat dissipated by all the modules must not exceed the heating capability of the cabinet where they are installed.

Element	Dissipated power
Leading (first) module.	2.0 watts.
Rest of modules.	0.8 W per module.

Clearance recommended around a group.

It is recommended to leave a gap between the group and the adjacent elements (other groups, cable carrying channels, enclosure walls, etc.) for better ventilation and easier handling of the unit later on.

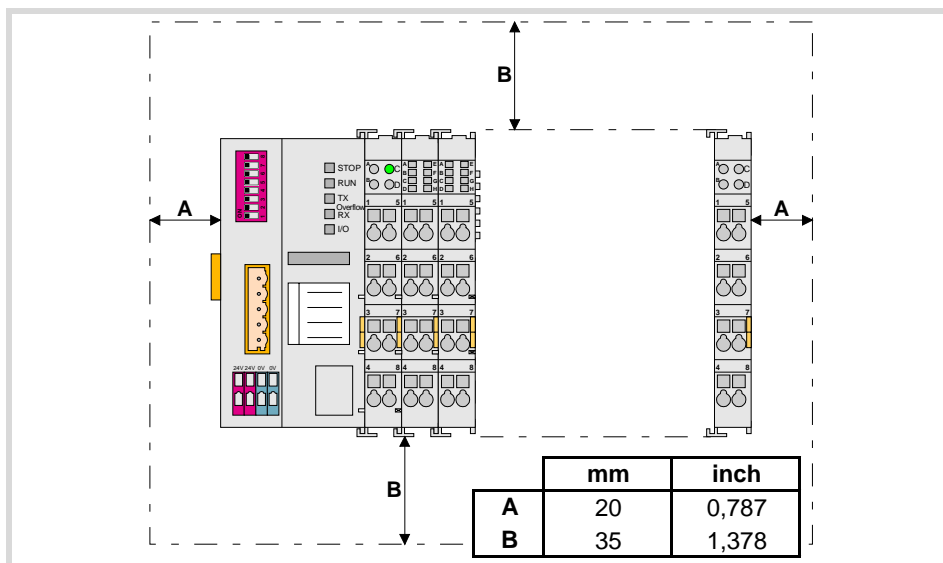

12.

RIOUW REMOTE MODULES. (CANOPEN PROTOCOL).

How to mount and dismount the modules.

Since the communication between the modules is done through the six-pin connector on the side of the modules, they must be latched to each other.



Do not touch the side pins of the bus to avoid soiling them, damaging them and any possible electrostatic discharges that could damage the module.

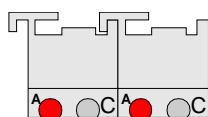

To ensure that the modules are joined together, they have some tabs on top and at the bottom. To join the modules together, slide each module onto the previous one, from top to bottom, making sure that the tabs latch onto each other.

Always mount the modules from left to right beginning with the leading module and always ending the group with the end module (last). To fix the leading module, once mounted on the rail, push onto the top groove of the locking disk located on the left side of the module. To free the module and be able to remove it from the rail, push on the bottom groove of the locking disk. To help remove a module from the rail, pull the unlocking tab located on the right side of the module.

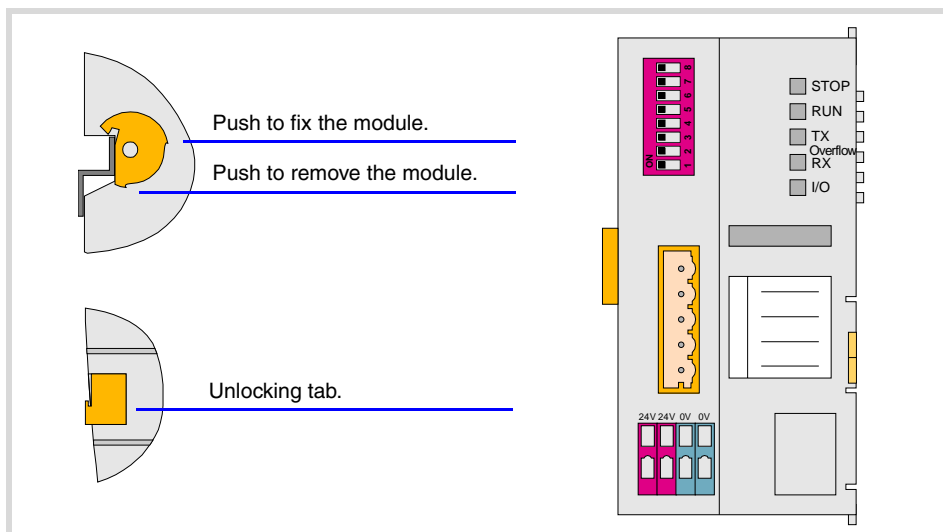

FAGOR 

CNC 8070

(REF: 1007)

Side voltage jumpers.

Some modules, e.g. the digital inputs module, have some jumpers on the left side for receiving and sending a current of 10 A needed to supply the module.

The jumpers of a module must latch into the grooves of the previous module. It must be borne in mind that not all the modules have the same number of jumpers and grooves. Before mounting a module with jumpers, make sure that the previous module has enough grooves to receive the jumpers.



The voltage jumpers are sharp. Handle the modules carefully to prevent getting hurt.

Cable connection.

DO NOT make any connection or connect any module or cable if the group is under power. Before making any connection, disconnect the power supply cable of the leading (first) module (RIOW-CANOPEN) and, if necessary, that of the power supply module (RIOW-PS24).

Each connector only admits one cable. To insert several cables into one connector, join the cables at a terminal and insert the terminal into the connector.

The cables are secured into the connectors by pressure. Insert a tool into the square hole located on top of the connector, this opens the connector. Insert the cable into the connector and remove the tool. After removing the tool, the cable stays fixed.

12.**RIOW REMOTE MODULES. (CANOPEN PROTOCOL).**

12.5 RIOW-CANOPEN-ECO module. Leading (first) module.

The RIOW-CANOPEN-ECO module must be present in all the groups and must be the first module of the group. This module is in charge of managing the internal bus of the group and connecting the group to the CAN bus of the system.

Power the module with an external 24 V DC (between -15% and +20%) regulated power supply.

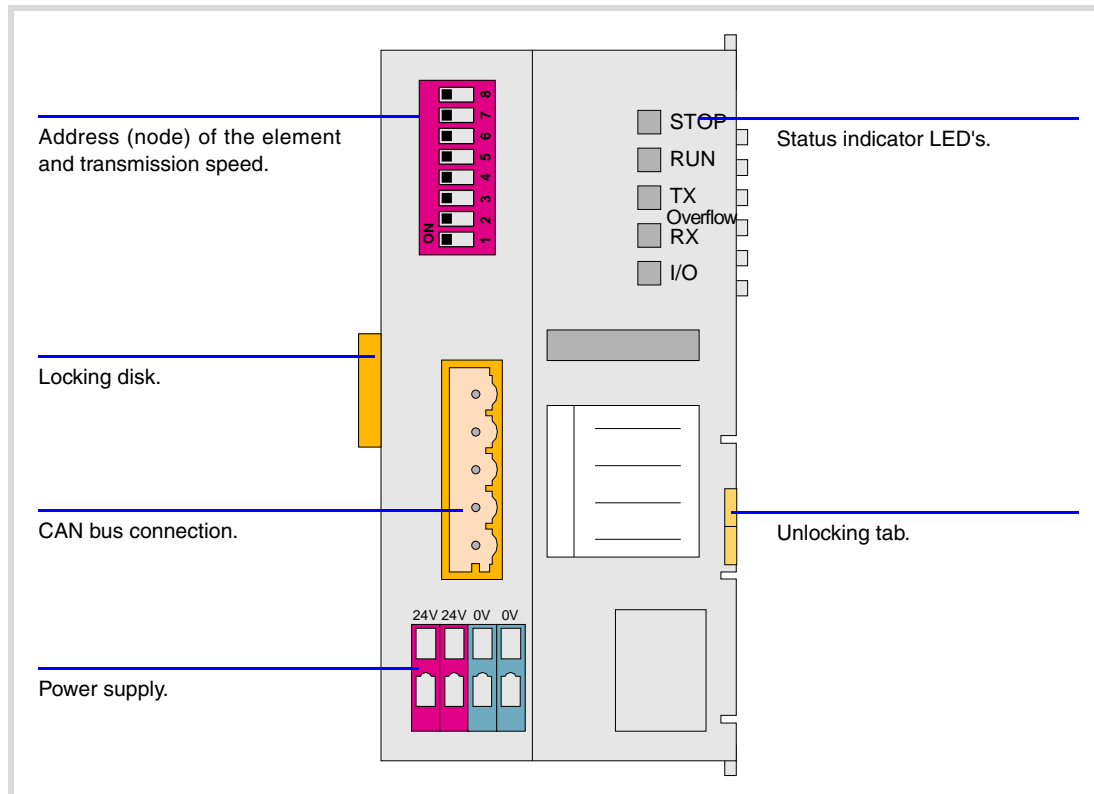

12.

RIOW REMOTE MODULES. (CANOPEN PROTOCOL).

12.5.1 Elements (connectors).

Power supply.

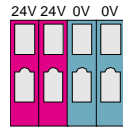

Signal	Function
24 V	Power supply.
0 V	Power supply.

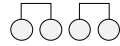

CAN bus connection.

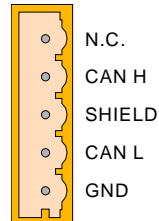

Pin	Signal	Function
5	N.C.	Not being used.
4	CAN H	(HIGH) bus signal.
3	SHIELD	CAN shield.
2	CAN L	(LOW) bus signal.
1	GND	Ground / 0 V.

Address (node) of the element and transmission speed.

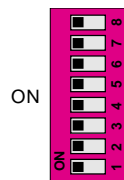

The dipswitch may be used to select the address of the node and the transmission speed. See "[12.5.2 Node configuration](#)." on page 155.

When using the CANopen protocol, the transmission speed at the bus is defined in each node. All the nodes must work at the same speed.



The dip-switch of the RIOW-CANOPEN-ECO and RIOW-CANOPEN-STAND modules is the same but rotated 180°, so the .ON. position is inverted between them.

Status indicator LED's.

The module has the following LED's on top. These LED's indicate the status of the node and of the communication through the CAN bus. See "[12.5.3 Meaning of the LED's](#)." on page 157.

LED.	Color.	Meaning.
STOP	Red.	The node is stopped.
RUN	Green.	The node works properly.
TX overflow	Red.	Data sending error.
RX overflow	Red.	Data reception error.
I/O	Red. Green. Orange.	Status of the communication with the I/O modules.

12.5.2 Node configuration.

The node is configured using the dipswitches to select the node address and the transmission speed.

Configuring the node speed.

To select the speed of the node, the module must be in configuration mode (all the dipswitches in the *-off-* position). After turning the module on in configuration mode, the top 4 LED's of the module blink indicating the speed selected at the module. The STOP LED corresponds to dipswitch *-1-*, the RUN to dipswitch *-2-*, the TX to dipswitch *-3-* and the RX to dipswitch *-4-*. The first time the module is configured, the TX LED blinks indicating that no valid speed has been selected.



If when turning the module on, all the dipswitches are not in the -off- position, the position of the dipswitches will be the new address (node number) of the group.

The first 4 dipswitches are used to select the speed; the rest must be in the *-off-* position. To select the speed, put the corresponding dipswitches in the *-on-* position. The transmission speed depends on the total length of the cable. Use the following approximate values. Assigning other values may cause communication errors due to signal distortion.

Dipswitch	Speed	Length of the CAN bus.
	1000 kHz	Up to 20 meters.
	800 kHz	From 20 to 40 meters.
	500 kHz	From 40 to 100 meters.
	250 kHz	From 100 to 500 meters.

To save the selected speed, put dipswitch *-8-* in the *-on-* position. After saving the configuration, the corresponding LED's turn on to indicate the module speed. For 1 MHz, all four LED's turn on.

Once the speed has been selected, turn the module off by removing power and set dip-switch *-8-* in the *-off-* position. Bear in mind that the next time the module is turned on, the position of the dipswitches will indicate the address (node number) of the group.

Configuring the address (node number) of the group.

Each one of the elements integrated into the CAN bus is identified by its address or node number. The CNC must always occupy position "0" and the rest of the elements of the bus will occupy consecutive positions starting with 1.

The address (node number) of the group is selected while the module is off. Select the speed by putting the corresponding dipswitches in the *-on-* position. The binary meaning of each dipswitch increases according to its number; dipswitch *-1-* for address 1, dipswitch *-3-* for address 4 and so on.

<p>Address <i>-1-</i>.</p>	<p>Address <i>-3-</i>.</p>	<p>Address <i>-9-</i>.</p>
----------------------------	----------------------------	----------------------------

Line terminating resistor.

In the CAN bus, it is necessary to use a line terminating resistor to identify which are the elements that occupy the ends of the bus; i.e. the first and last physical element in the connection. For the central unit, the terminating resistor is factory installed because the CNC is always at one end of the bus.

The RIOW series modules do not have a factory-installed line terminating resistor. The RIOW module mounted at the end of the bus must have a 120 Ω line terminating resistor between pins CAN_H and CAN_L to avoid signal deflections (rebounds).

12.

RIOW REMOTE MODULES. (CANOPEN PROTOCOL).



CNC 8070

(REF: 1007)

12.5.3 Meaning of the LED's.

While starting the module up, the LED's indicate the stage the node is in and its status.

Node status.	Meaning.
Initializing stage	<p>After starting up or after a reset, the module goes into the initializing stage to run an autotest. During the initializing stage, the I/O LED blinks orange until it changes to red.</p> <ul style="list-style-type: none"> • If the module is properly initialized, it changes to the pre-operative stage, the I/O LED changes to green and the RUN LED blinks. • If the module detects any problem in the initializing stage, it changes to the stop stage, the I/O LED blinks red and the STOP LED turns on. The blinking rate of the I/O LED indicates the detected error.
Pre-operative stage.	<p>In this stage, the module configures the bus. During the pre-operative stage, the I/O LED turns green and the RUN LED blinks.</p>
Operative stage.	<p>In this stage, the module is ready to work. In the operative stage, the I/O and RUN LED's turn green.</p>
Stop stage.	<p>This stage indicates an error at the node. The STOP LED turns on in the stop stage.</p>

When a module is in configuration mode (dipswitch value equal to -0-), the LED's indicate the speed selected at the module. See "[12.5.2 Node configuration.](#)" on page 155.

LED's STOP, RUN, TX overflow and RX overflow.

The top four LED's of the module (STOP, RUN, TX overflow and RX overflow) indicate the status of the node and of the communication through the CAN bus.

STOP	RUN	Meaning.
OFF	OFF	Module turned off or in initializing stage.
OFF	Blinking slow	Module in pre-operative stage.
OFF	ON	Module in operative stage.
ON	OFF	Module in stop stage. Node configuration error or bus error.
OFF	Blinking fast	Module in pre-operative stage. Module error.
Blinking fast	Blinking fast	Module in pre-operative stage. Module error.
Blinking fast	OFF	Module in pre-operative stage. Module error.

TX overflow	RX overflow	Meaning.
OFF	OFF	Module turned off or in initializing stage.
- - -	ON	Data reception error.
ON	- - -	Data sending error.
Blinking fast	Blinking fast	Too many errors at the node.

Led I/O.

Three-colored LED (orange/red/green) that indicates the bus status and the errors found.

Led I/O.	Meaning.
Off.	There's no data at the data bus.
Green.	The module is transmitting data.
Red.	Hardware error.
Blinking orange.	The module is in the initializing stage.
Blinking red.	Data bus error.
Cyclic red blinking.	Error code.

Start the module up, the LED blinks orange until it changes to red. If the module is successfully initialized, the LED changes to green. If the module detects a problem the LED keeps blinking red. The module shows the error code, cyclically, by three blinking sequences.

- The first blinking sequence (10 Hz) indicates that there are errors at the node.
- After a pause, the module offers the second blinking sequence (1 Hz). The number of blinks indicates the error code.
- After a longer pause, the module offers the third blinking sequence (1 Hz). The number of blinks indicates the type of error.

12.

RIO W REMOTE MODULES. (CANOPEN PROTOCOL).

Error 1: Hardware and configuration error at the node.

Type.	Description.	Solution.
1	Overflow at the internal data memory of the module.	Remove power from the node, reduce the number of modules and apply power to the node again. If the error persists, replace the leading (first) module.
2	Wrong I/O module at the node.	Replace wrong module. If the error persists, update the firmware of the leading (first) module. To locate the wrong module, repeat the following sequence as often as necessary. <ul style="list-style-type: none"> • Remove power from the node, place the end module in the middle of the node and apply power to the node again. • If the error persists, remove power from the node again, place the end module in the middle of the first half of the node and apply power to the node again. • If there are no errors, remove power from the node again, place the end module in the middle of the second half of the node and apply power to the node again. If there is only one I/O module left in the node, that module will be the wrong one.
3	Checksum error in EEPROM data.	Remove power from the node, replace the leading module and apply power to the node again.
4	Error while writing EEPROM.	Remove power from the node, replace the leading module and apply power to the node again.
5	Error while reading EEPROM.	Remove power from the node, replace the leading module and apply power to the node again.
6	The configuration of the I/O modules has changed after a reset.	Initialize the module by removing power and applying it again.
7	Reserved.	
8	Timeout error in the EEPROM.	Remove power from the node, replace the leading module and apply power to the node again.
9	Reserved.	

Error 2: Configuration error at the node.

Type.	Description.	Solution.
1	The image with the information on the modules is not active.	Contact Fagor Automation.
2	The image with the information on the modules is too large.	Remove power from the node, reduce the number of modules and apply power to the node again.
3	The image with the information on the modules is missing.	Contact Fagor Automation.



CNC 8070

(REF: 1007)

Error 3: Error in the protocol of the internal bus of the node.

Type.	Description.	Solution.
---	Communication error at the bus. Wrong module not found.	<p>Replace wrong module. To locate the wrong module, repeat the following sequence as often as necessary.</p> <ul style="list-style-type: none"> Remove power from the node, place the end module in the middle of the node and apply power to the node again. If the error persists, remove power from the node again, place the end module in the middle of the first half of the node and apply power to the node again. If there are no errors, remove power from the node again, place the end module in the middle of the second half of the node and apply power to the node again. <p>If there is only one I/O module left in the node, that module or the leading module will be the wrong one.</p>

Error 4: Physical error in the internal bus of the node.

Type.	Description.	Solution.
---	Communication error at the bus or the bus is interrupted.	<p>Replace wrong module. Place an I/O module after the leading module and check if it causes an error. If there are no errors, replace the leading (first) module.</p> <p>If the leading module is correct, replace the wrong I/O module. To locate the wrong module, repeat the following sequence as often as necessary.</p> <ul style="list-style-type: none"> Remove power from the node, place the end module in the middle of the node and apply power to the node again. If the error persists, remove power from the node again, place the end module in the middle of the first half of the node and apply power to the node again. If there are no errors, remove power from the node again, place the end module in the middle of the second half of the node and apply power to the node again. <p>If there is only one I/O module left in the node, that module or the leading module will be the wrong one.</p>
n	The bus is interrupted after the n-th module. The number of blinks indicates the n position of the I/O module.	Remove power from the node, replace the (n+1)th module and apply power to the node again.

Error 5: Internal-bus initializing error.

Type.	Description.	Solution.
n	Communication error while initializing the module. The number of blinks indicates the n position of the I/O module.	Remove power from the node, replace the n-th module and apply power to the node again.

12.

RIOW REMOTE MODULES. (CANOPEN PROTOCOL).

FAGOR 

CNC 8070

(REF: 1007)

12.6 RIOW-CANOPEN-STAND module. Leading (first) module.

The RIOW-CANOPEN-STAND module must be present in all the groups and must be the first module of the group. This module is in charge of managing the internal bus of the group, connecting the group to the system CAN bus and supplying power to the I/O modules through the side jumpers with 24 V 10 A. If when configuring the remote group, the consumption of the I/O modules is higher, additional RIOW-PS24 modules must be added.

Power the module with an external 24 V DC (between -15% and +20%) regulated power supply. Using the wrong voltage may cause severe damage to the components.

12.

RIOW REMOTE MODULES. (CANOPEN PROTOCOL).

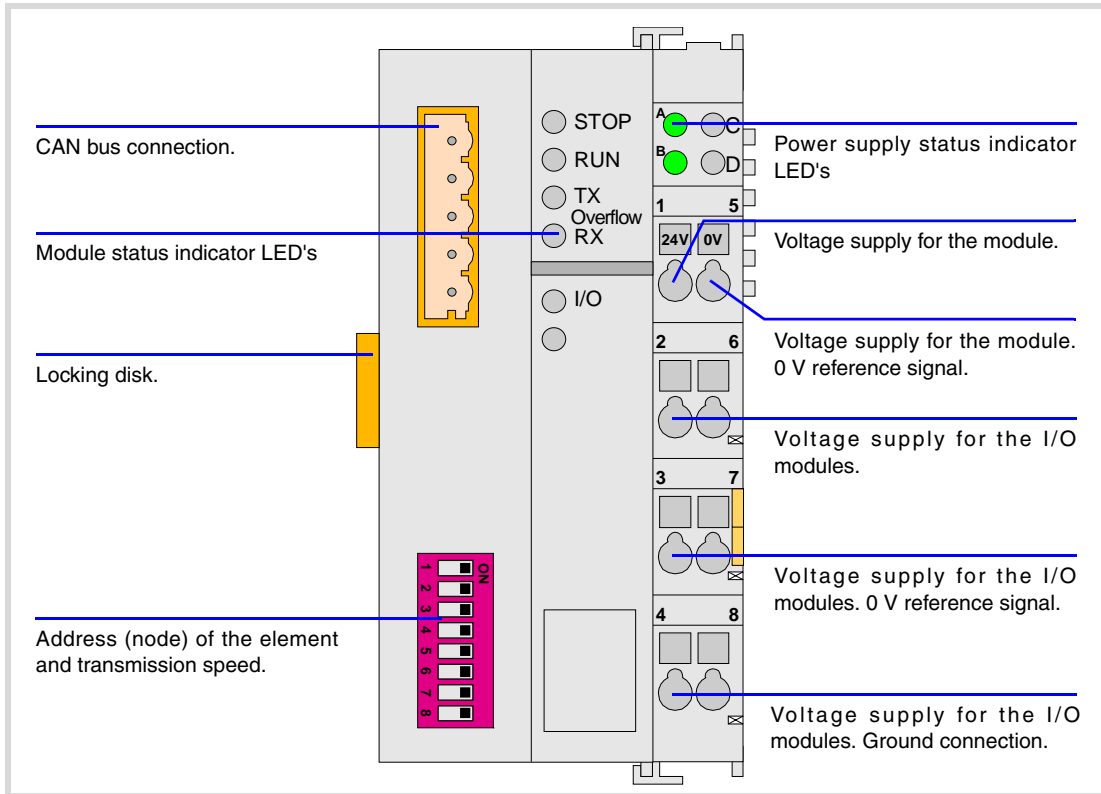

12.6.1 Elements (connectors).

CAN bus connection.

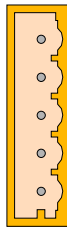

N.C.
CAN H
SHIELD
CAN L
GND

Pin	Signal	Function
5	N.C.	Not being used.
4	CAN H	(HIGH) bus signal.
3	SHIELD	CAN shield.
2	CAN L	(LOW) bus signal.
1	GND	Ground / 0 V.

Address (node) of the element and transmission speed.



ON

The dipswitch may be used to select the address of the node and the transmission speed. See "[12.6.3 Node configuration.](#)" on page 164.

When using the CANopen protocol, the transmission speed at the bus is defined in each node. All the nodes must work at the same speed.



The dip-switch of the RIOW-CANOPEN-ECO and RIOW-CANOPEN-STAND modules is the same but rotated 180°, so the -ON- position is inverted between them.

Status indicator LED's.

The module has the following LED's on top. These LED's indicate the status of the node and of the communication through the CAN bus. See "[12.6.4 Meaning of the LED's.](#)" on page 166.

LED.	Color.	Meaning.
STOP	Red.	The node is stopped.
RUN	Green.	The node works properly.
TX overflow	Red.	Data sending error.
RX overflow	Red.	Data reception error.

LED.	Color.	Meaning.
I/O	Green.	Status of the communication with the I/O modules.
I/O	Red.	Status of the communication with the I/O modules.

Power supply.

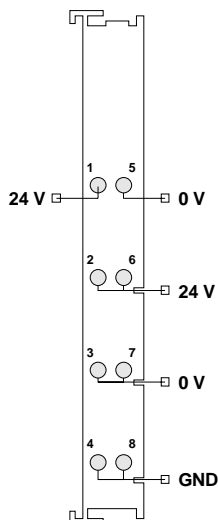

Pin	Function
1	Voltage supply for the module. 24 V supply input.
5	Voltage supply for the module. 0 V reference signal.
2 - 6	Voltage supply for the I/O modules. 24 V supply input.
3 - 7	Voltage supply for the I/O modules. 0 V reference signal.
4 - 8	Voltage supply for the I/O modules. Ground connection.

Power supply status indicator LED's

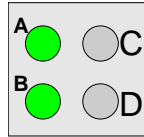

Led	Color	Function
A	Green	The LED turns on when the module is under power.
B	Green	The LED turns on if the side jumpers have 24 V.

12.

RIOW REMOTE MODULES. (CANOPEN PROTOCOL).



CNC 8070

(REF: 1007)

12.6.2 Voltage supply for the module.

Power for the module and for the rest of the modules must be separated in order to ensure the operations in the bus in case of a short-circuit on the side of the actuator.

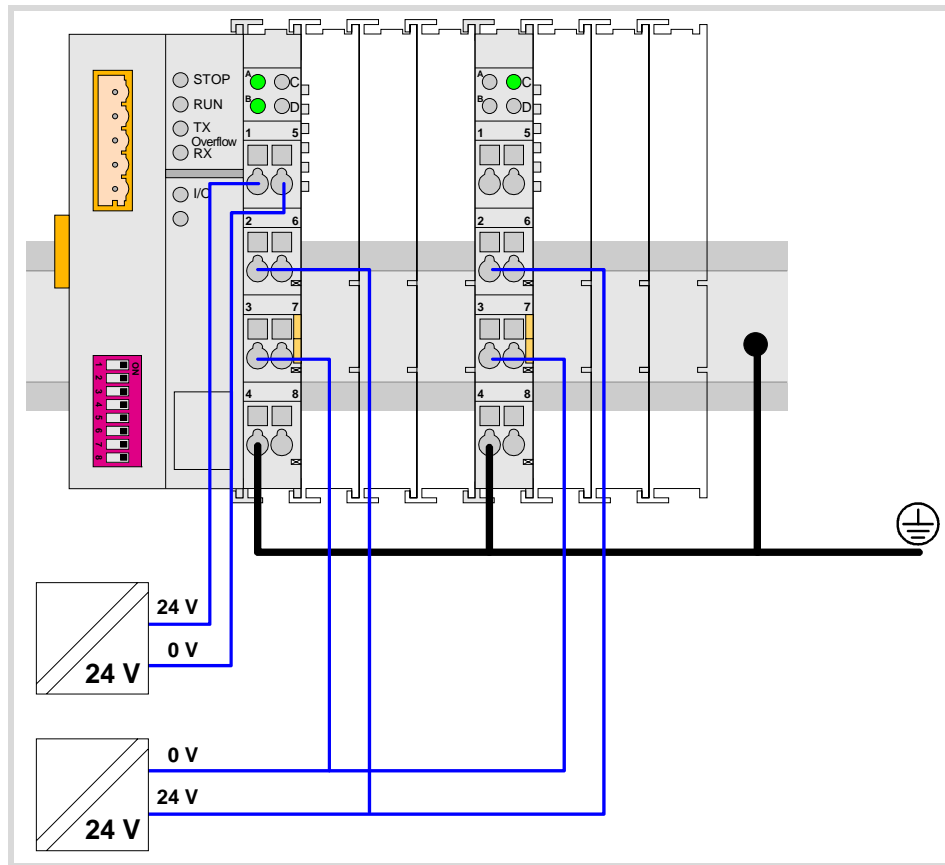

12.

RIOW REMOTE MODULES. (CANOPEN PROTOCOL).

12.6.3 Node configuration.

The node is configured using the dipswitches to select the node address and the transmission speed.

Configuring the node speed.

To select the speed of the node, the module must be in configuration mode (all the dipswitches in the -off- position). After turning the module on in configuration mode, the top 4 LED's of the module blink indicating the speed selected at the module. The STOP LED corresponds to dipswitch -1-, the RUN to dipswitch -2-, the TX to dipswitch -3- and the RX to dipswitch -4-. The first time the module is configured, the TX LED blinks indicating that no valid speed has been selected.



If when turning the module on, all the dipswitches are not in the -off- position, the position of the dipswitches will be the new address (node number) of the group.

The first 4 dipswitches are used to select the speed; the rest must be in the -off- position. To select the speed, put the corresponding dipswitches in the -on- position. The transmission speed depends on the total length of the cable. Use the following approximate values. Assigning other values may cause communication errors due to signal distortion.

Dipswitch	Speed	Length of the CAN bus.
1 <input type="checkbox"/> 2 <input type="checkbox"/> ON 3 <input type="checkbox"/> 4 <input type="checkbox"/>	1000 kHz	Up to 20 meters.
1 <input type="checkbox"/> 2 <input type="checkbox"/> ON 3 <input type="checkbox"/> 4 <input type="checkbox"/>	800 kHz	From 20 to 40 meters.
1 <input type="checkbox"/> 2 <input type="checkbox"/> ON 3 <input type="checkbox"/> 4 <input type="checkbox"/>	500 kHz	From 40 to 100 meters.
1 <input type="checkbox"/> 2 <input type="checkbox"/> ON 3 <input type="checkbox"/> 4 <input type="checkbox"/>	250 kHz	From 100 to 500 meters.

To save the selected speed, put dipswitch -8- in the -on- position. After saving the configuration, the corresponding LED's turn on to indicate the module speed. For 1 MHz, all four LED's turn on.

Once the speed has been selected, turn the module off by removing power and set dip-switch -8- in the -off- position. Bear in mind that the next time the module is turned on, the position of the dipswitches will indicate the address (node number) of the group.

Configuring the address (node number) of the group.

Each one of the elements integrated into the CAN bus is identified by its address or node number. The CNC must always occupy position "0" and the rest of the elements of the bus will occupy consecutive positions starting with 1.

The address (node number) of the group is selected while the module is off. Select the speed by putting the corresponding dipswitches in the -on- position. The binary meaning of each dipswitch increases according to its number; dipswitch -1- for address 1, dipswitch -3- for address 4 and so on.

1 <input type="checkbox"/> 2 <input type="checkbox"/> ON 3 <input type="checkbox"/> 4 <input type="checkbox"/>	1 <input type="checkbox"/> 2 <input type="checkbox"/> ON 3 <input type="checkbox"/> 4 <input type="checkbox"/>	1 <input type="checkbox"/> 2 <input type="checkbox"/> ON 3 <input type="checkbox"/> 4 <input type="checkbox"/>
Address -1-.	Address -3-.	Address -9-.

12.

RIOV REMOTE MODULES. (CANOPEN PROTOCOL).



CNC 8070

(REF: 1007)

Line terminating resistor.

In the CAN bus, it is necessary to use a line terminating resistor to identify which are the elements that occupy the ends of the bus; i.e. the first and last physical element in the connection. For the central unit, the terminating resistor is factory installed because the CNC is always at one end of the bus.

The RIOW series modules do not have a factory-installed line terminating resistor. The RIOW module mounted at the end of the bus must have a 120 Ω line terminating resistor between pins CAN_H and CAN_L to avoid signal deflections (rebounds).

12.

RIOW REMOTE MODULES. (CANOPEN PROTOCOL).

12.6.4 Meaning of the LED's.

While starting the module up, the LED's indicate the stage the node is in and its status.

Node status.	Meaning.
Initializing stage	After starting up or after a reset, the module goes into the initializing stage to run an autotest. During the initializing stage, the I/O LED blinks orange until it changes to red. <ul style="list-style-type: none"> • If the module is properly initialized, it changes to the pre-operative stage, the I/O LED changes to green and the RUN LED blinks. • If the module detects any problem in the initializing stage, it changes to the stop stage, the I/O LED blinks red and the STOP LED turns on. The blinking rate of the I/O LED indicates the detected error.
Pre-operative stage.	In this stage, the module configures the bus. During the pre-operative stage, the I/O LED turns green and the RUN LED blinks.
Operative stage.	In this stage, the module is ready to work. In the operative stage, the I/O and RUN LED's turn green.
Stop stage.	This stage indicates an error at the node. The STOP LED turns on in the stop stage.

When a module is in configuration mode (dipswitch value equal to -0-), the LED's indicate the speed selected at the module. See "[12.6.3 Node configuration.](#)" on page 164.

LED's STOP, RUN, TX overflow and RX overflow.

The top four LED's of the module (STOP, RUN, TX overflow and RX overflow) indicate the status of the node and of the communication through the CAN bus.

STOP	RUN	Meaning.
OFF	OFF	Module turned off or in initializing stage.
OFF	Blinking slow	Module in pre-operative stage.
OFF	ON	Module in operative stage.
ON	OFF	Module in stop stage. Node configuration error or bus error.
OFF	Blinking fast	Module in pre-operative stage. Module error.
Blinking fast	Blinking fast	Module in pre-operative stage. Module error.
Blinking fast	OFF	Module in pre-operative stage. Module error.

TX overflow	RX overflow	Meaning.
OFF	OFF	Module turned off or in initializing stage.
- - -	ON	Data reception error.
ON	- - -	Data sending error.
Blinking fast	Blinking fast	Too many errors at the node.

Led I/O.

Three-colored LED (orange/red/green) that indicates the bus status and the errors found.

Led I/O.	Meaning.
off	There's no data at the data bus
Green.	The module is transmitting data.
Red.	Hardware error.
Blinking orange.	The module is in the initializing stage.
Blinking red.	Data bus error.
Cyclic red blinking.	Error code.

12.

RIO W REMOTE MODULES. (CANOPEN PROTOCOL).



CNC 8070

(REF: 1007)

Start the module up, the LED blinks orange until it changes to red. If the module is successfully initialized, the LED changes to green. If the module detects a problem the LED keeps blinking red. The module shows the error code, cyclically, by three blinking sequences.

- The first blinking sequence (10 Hz) indicates that there are errors at the node.
- After a pause, the module offers the second blinking sequence (1 Hz). The number of blinks indicates the error code.
- After a longer pause, the module offers the third blinking sequence (1 Hz). The number of blinks indicates the type of error.

Error 1: Hardware and configuration error at the node.

Type.	Description.	Solution.
- - -	Checksum error in the data.	Remove power from the node, reduce the number of I/O modules and apply power to the node again.
1	Overflow at the internal data memory of the module.	Remove power from the node, reduce the number of I/O modules and apply power to the node again. If the error persists, replace the leading (first) module.
2	Wrong I/O module at the node.	Replace wrong module. If the error persists, update the firmware of the leading (first) module. To locate the wrong module, repeat the following sequence as often as necessary. <ul style="list-style-type: none"> • Remove power from the node, place the end module in the middle of the node and apply power to the node again. • If the error persists, remove power from the node again, place the end module in the middle of the first half of the node and apply power to the node again. • If there are no errors, remove power from the node again, place the end module in the middle of the second half of the node and apply power to the node again. If there is only one I/O module left in the node, that module will be the wrong one.
3	The type of module stored in the flash cannot be identified or is wrong.	Remove power from the node, replace the leading module and apply power to the node again.
4	Error while writing in Flash memory.	Remove power from the node, replace the leading module and apply power to the node again.
5	Error while deleting the Flash memory.	Remove power from the node, replace the leading module and apply power to the node again.
6	The configuration of the I/O modules has changed after a reset.	Initialize the module by removing power and applying it again.
7	Error when writing EEPROM data.	Remove power from the node, replace the leading module and apply power to the node again.
8	Wrong hardware and firmware combination.	Remove power from the node, replace the leading module and apply power to the node again.
9	Checksum error in the EEPROM.	Remove power from the node, replace the leading module and apply power to the node again.
10	Error when initializing the EEPROM.	Remove power from the node, replace the leading module and apply power to the node again.
11	Timeout error when reading EEPROM data.	Remove power from the node, replace the leading module and apply power to the node again.

12.

Type.	Description.	Solution.
12	Timeout error when writing EEPROM data.	Remove power from the node, replace the leading module and apply power to the node again.
13	Reserved.	
14	Reserved.	

Error 2: Not being used.

Type.	Description.	Solution.
- - -	Not being used	- - -

Error 3: Error in the protocol of the internal bus of the node.

Type.	Description.	Solution.
- - -	Communication error at the bus. Wrong module not found.	<p>Replace wrong module. To locate the wrong module, repeat the following sequence as often as necessary.</p> <ul style="list-style-type: none"> Remove power from the node, place the end module in the middle of the node and apply power to the node again. If the error persists, remove power from the node again, place the end module in the middle of the first half of the node and apply power to the node again. If there are no errors, remove power from the node again, place the end module in the middle of the second half of the node and apply power to the node again. <p>If there is only one I/O module left in the node, that module or the leading module will be the wrong one.</p>

Error 4: Physical error in the internal bus of the node.

Type.	Description.	Solution.
- - -	Communication error at the bus or the bus is interrupted.	<p>Replace wrong module. Place an I/O module after the leading module and check if it causes an error. If there are no errors, replace the leading (first) module.</p> <p>If the leading module is correct, replace the wrong I/O module. To locate the wrong module, repeat the following sequence as often as necessary.</p> <ul style="list-style-type: none"> Remove power from the node, place the end module in the middle of the node and apply power to the node again. If the error persists, remove power from the node again, place the end module in the middle of the first half of the node and apply power to the node again. If there are no errors, remove power from the node again, place the end module in the middle of the second half of the node and apply power to the node again. <p>If there is only one I/O module left in the node, that module or the leading module will be the wrong one.</p>
n	The bus is interrupted after the n-th module. The number of blinks indicates the n position of the I/O module.	Remove power from the node, replace the (n+1)th module and apply power to the node again.

Error 5: Internal-bus initializing error.

Type.	Description.	Solution.
n	Communication error while initializing the module. The number of blinks indicates the n position of the I/O module.	Remove power from the node, replace the n-th module and apply power to the node again.

12.

RIOW REMOTE MODULES. (CANOPEN PROTOCOL).



CNC 8070

(REF: 1007)

12.7 RIOW-PS24 module.

This module is in charge of supplying power to the I/O modules through the side jumpers with 24 V 10 A. If when configuring the remote group, the consumption of the I/O modules is higher, additional RIOW-PS24 modules must be added.

Power the module with an external 24 V DC regulated power supply.

12.

RIOW REMOTE MODULES. (CANOPEN PROTOCOL).

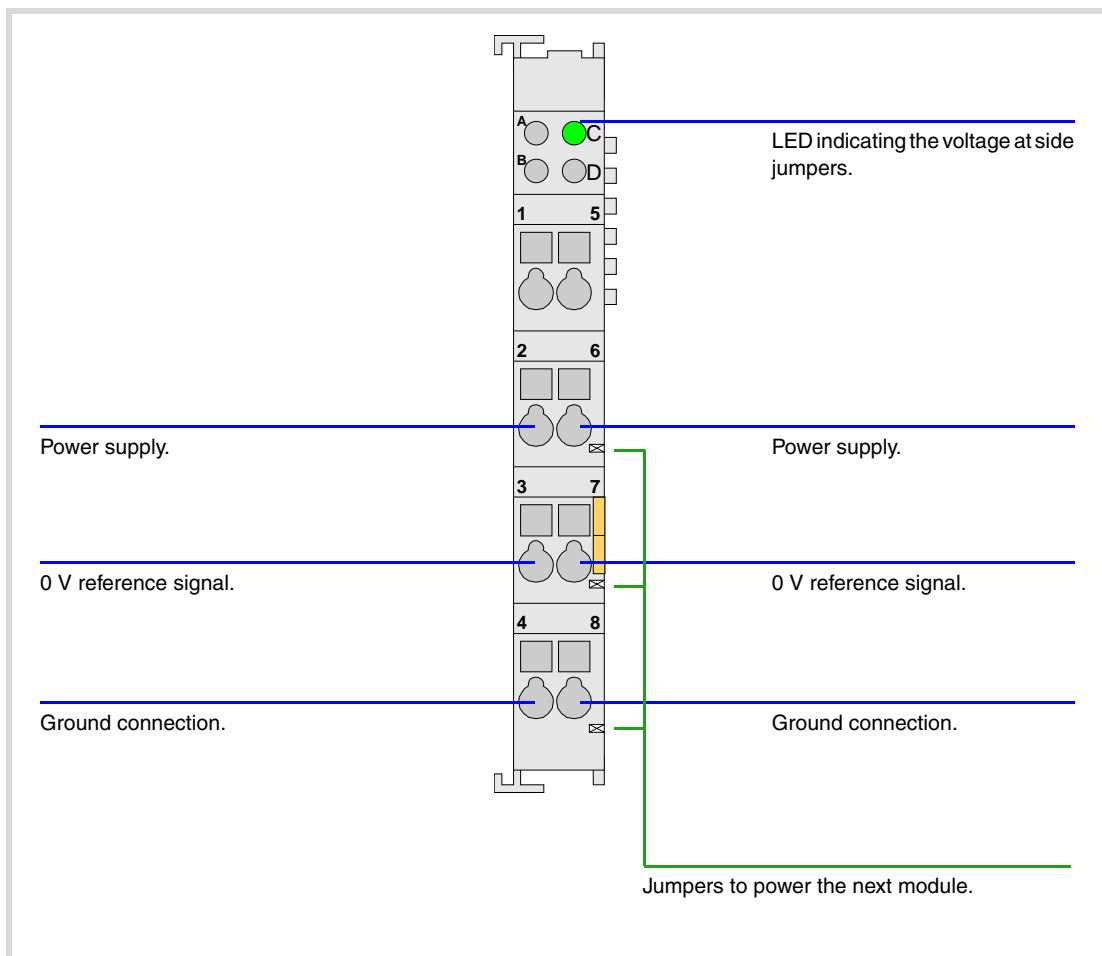

12.7.1 Elements (connectors).

Power supply.

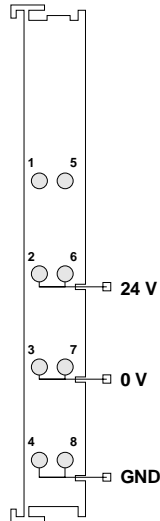

Signal	Function
24 V	Power supply.
0 V	0 V reference signal.
GND	Ground connection.

Status indicator LED's.

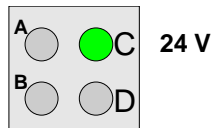

The LED is green. The LED turns on if the side jumpers have 24 V.

12.8 RIOW-8DI module. Module of 8 digital inputs.

Expansion module with eight 24 V DC digital inputs. The module has an LED indicating the status for each input.

The 24 V DC needed to power the module comes from the previous module (inputs, outputs module or power supply module) through the side power supplying jumpers). Likewise, this module can also power the next module through the same jumpers. This module, by itself, does not generate any voltage; it just receives the voltage generated by the previous RIOW-PS24 module and passes it on to the next module.

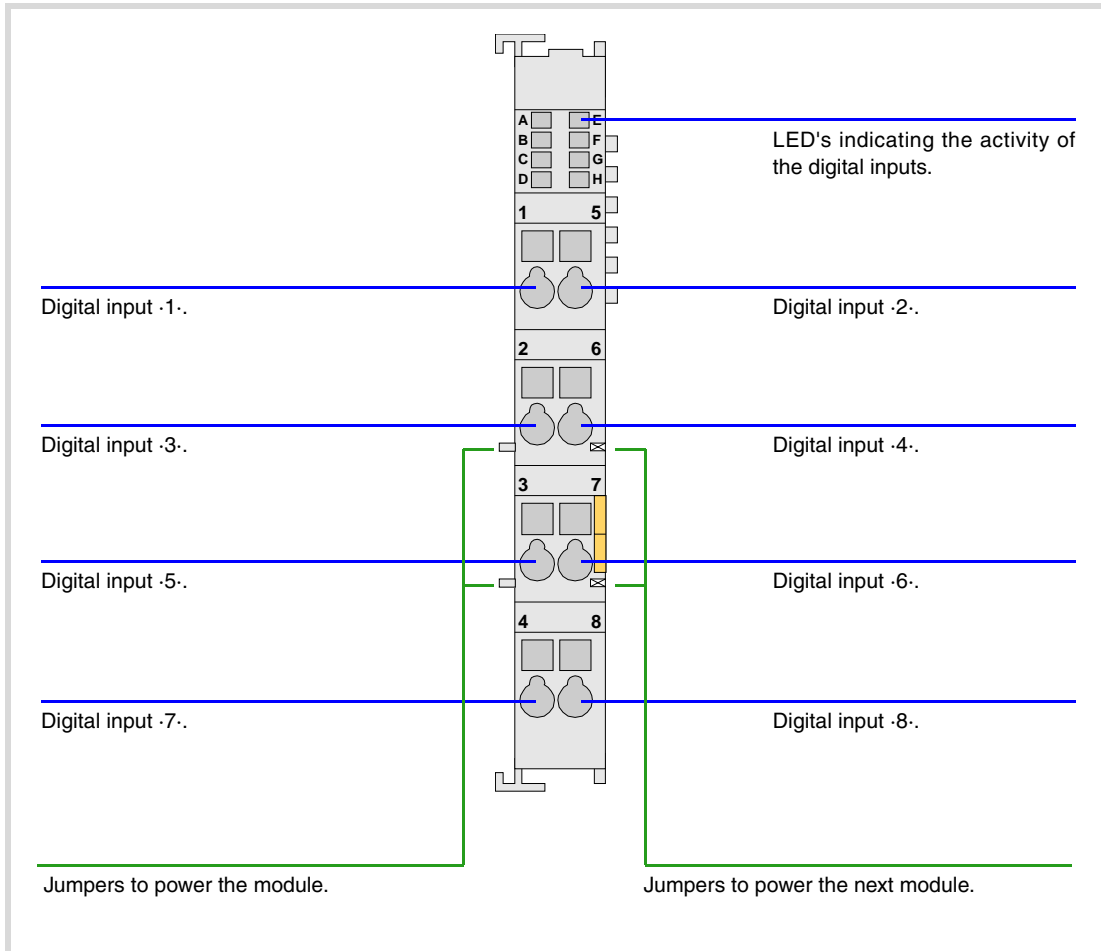

12.

RIOW REMOTE MODULES. (CANOPEN PROTOCOL).



CNC 8070

(REF: 1007)

12.8.1 Elements (connectors).

Digital inputs (8 inputs).

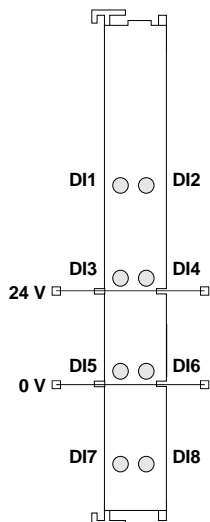

Signal	Function
24 V	Power supply.
0 V	Power supply.
DI1 - DI8	Digital inputs.

Status indicator LED's.

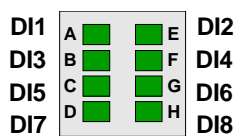

Green LED's. All digital inputs have a status indicating LED that turns on when the input is active.

12.

RIOUW REMOTE MODULES. (CANOPEN PROTOCOL).

12.9 RIOW-8DO module. Module of 8 digital outputs.

Expansion module with eight 24 V DC 0,5 A digital outputs. The module has an LED indicating the status for each output.

The 24 V DC needed to power the module comes from the previous module (inputs, outputs module or power supply module) through the side power supplying jumpers). Likewise, this module can also power the next module through the same jumpers. This module, by itself, does not generate any voltage; it just receives the voltage generated by the previous RIOW-PS24 module and passes it on to the next module.

12.

RIOW REMOTE MODULES. (CANOPEN PROTOCOL).

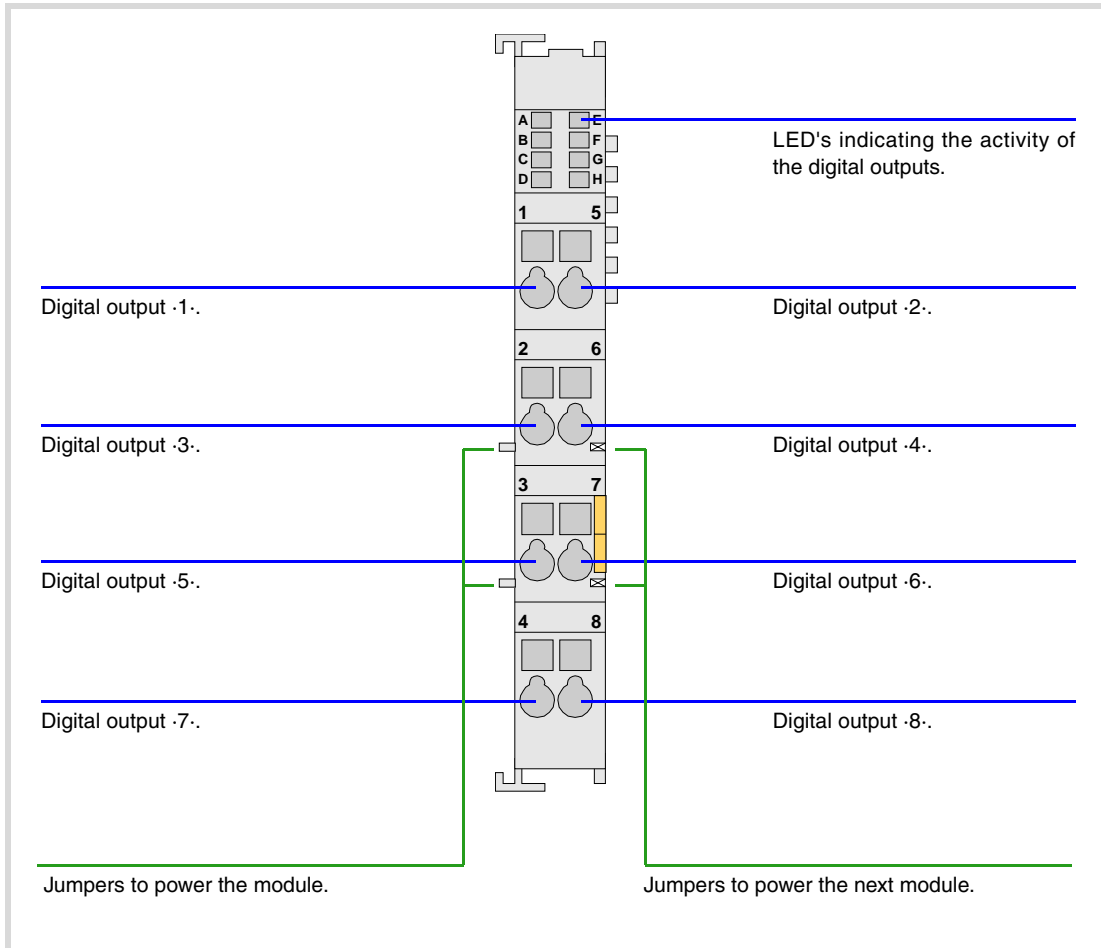

12.9.1 Elements (connectors).

Digital outputs (8 outputs).

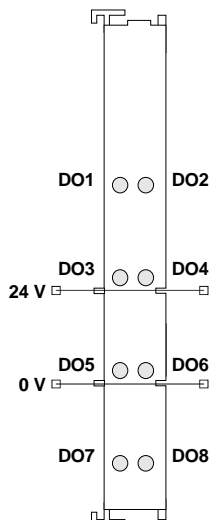

Signal	Function
24 V	Power supply.
0 V	Power supply.
DO1 - DO8	Digital outputs.

Status indicator LED's.

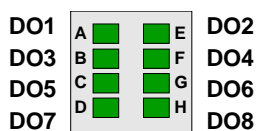

Green LED's. All digital outputs have a status indicating LED that turns on when the output is active.

12.

RIOW REMOTE MODULES. (CANOPEN PROTOCOL).

12.10 RIOW-4AI module. Module of 4 analog inputs.

Expansion module with four ± 10 V DC analog inputs. The module has an LED indicating the status for each input.

The 24 V DC needed to power the module comes from the previous module (inputs, outputs module or power supply module) through the side power supplying jumpers). Likewise, this module can also power the next module through the same jumpers. This module, by itself, does not generate any voltage; it just receives the voltage generated by the previous RIOW-PS24 module and passes it on to the next module.

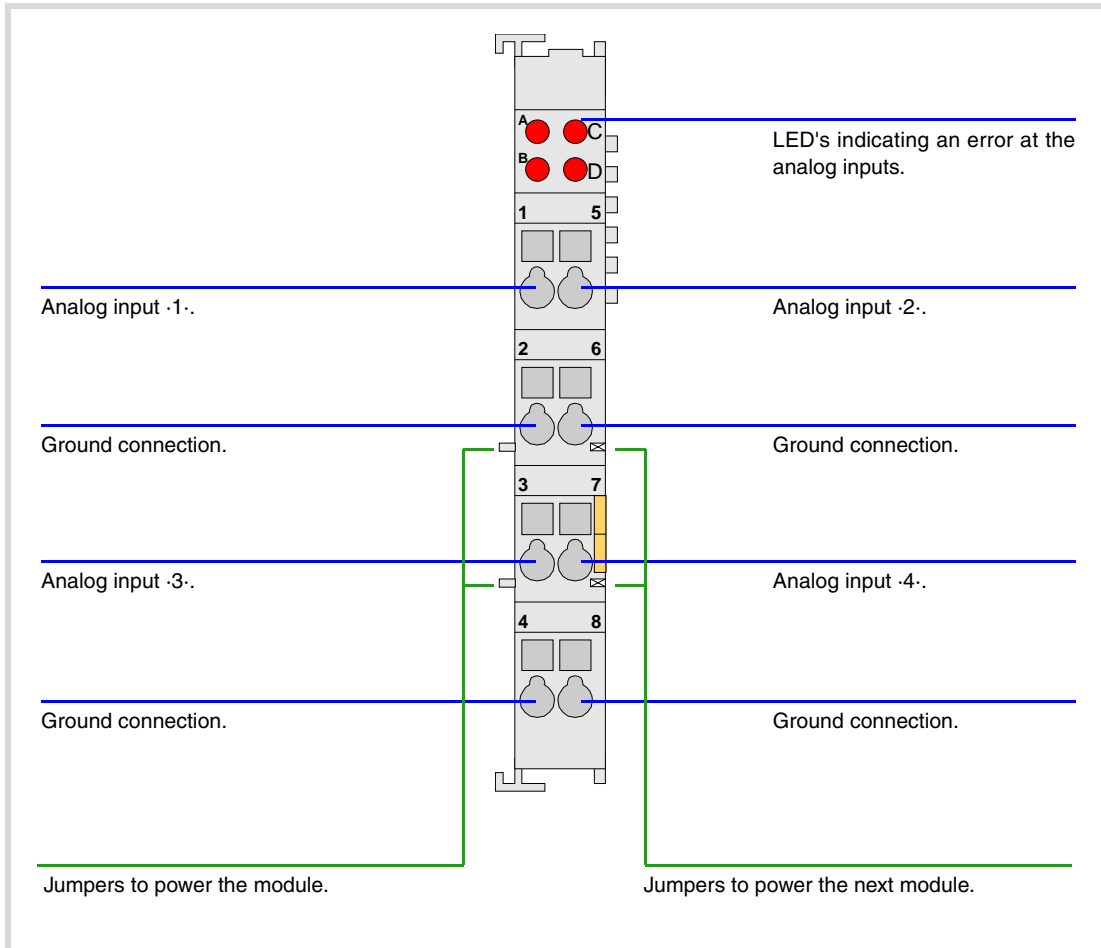

12.

RIOW REMOTE MODULES. (CANOPEN PROTOCOL).



CNC 8070

(REF: 1007)

12.10.1 Elements (connectors).

Analog inputs (4 inputs).

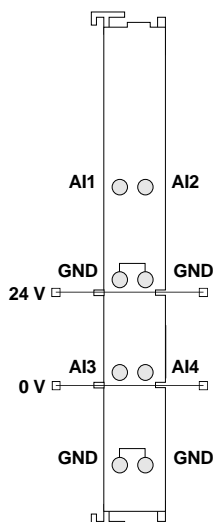

Signal	Function
AI1 - AI4	Analog inputs.
GND	Ground connection.
0 V	Power supply.
24 V	Power supply.

Connectors ·2· and ·6· are joined together internally.
Connectors ·4· and ·8· are joined together internally.

Status indicator LED's.

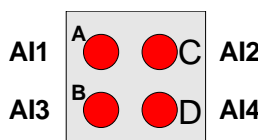

Red LED's. All analog inputs have a status indicating LED that turns on when there is an over-voltage or an under-voltage.

12.11 RIOW-4AO module. Module of 4 analog outputs.

Expansion module with four ± 10 V DC analog outputs. The module has an LED indicating the status of the bus and an LED indicating an error at any of the outputs.

The 24 V DC needed to power the module comes from the previous module (inputs, outputs module or power supply module) through the side power supplying jumpers. Likewise, this module can also power the next module through the same jumpers. This module, by itself, does not generate any voltage; it just receives the voltage generated by the previous RIOW-PS24 module and passes it on to the next module.

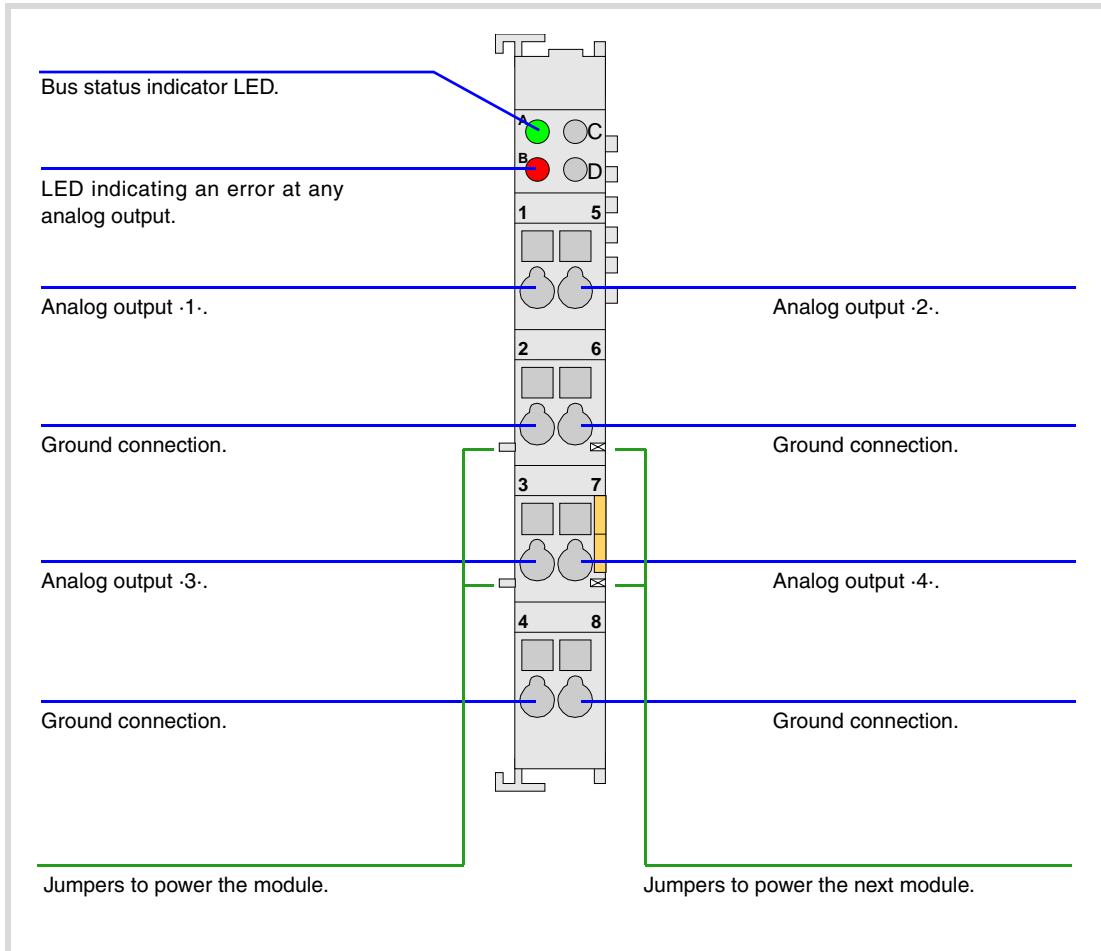

12.

RIOW REMOTE MODULES. (CANOPEN PROTOCOL).



CNC 8070

(REF: 1007)

12.11.1 Elements (connectors).

Analog outputs (4 outputs).

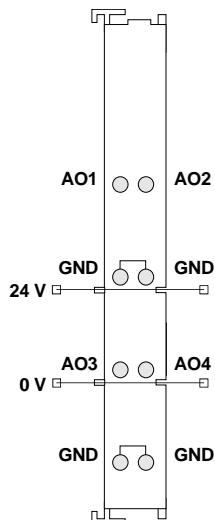

Signal	Function
AO1 - AO4	Analog outputs.
GND	Ground connection.
0 V	Power supply.
24 V	Power supply.

All ·GND· connectors are joined together internally.

Led ·BUS·. Data bus status.

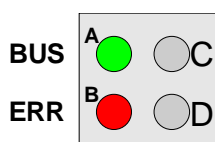

Green LED's. The LED turns on when transmission at the bus is OK.

Led ·ERR·. Error at the outputs.

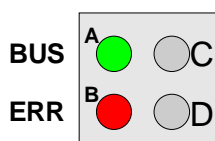

Red LED's. The LED turns on if there is an overload or a short-circuit to ground at any of the outputs.

12.12 RIOW-2AI-PT100 module. Module of 2 inputs for PT100 temperature sensors.

Expansion module with 2 analog inputs for PT100 temperature sensors. Each input has an LED indicating the status of the bus and an LED indicating a measuring error of the sensor.

12.

RIOW REMOTE MODULES. (CANOPEN PROTOCOL).

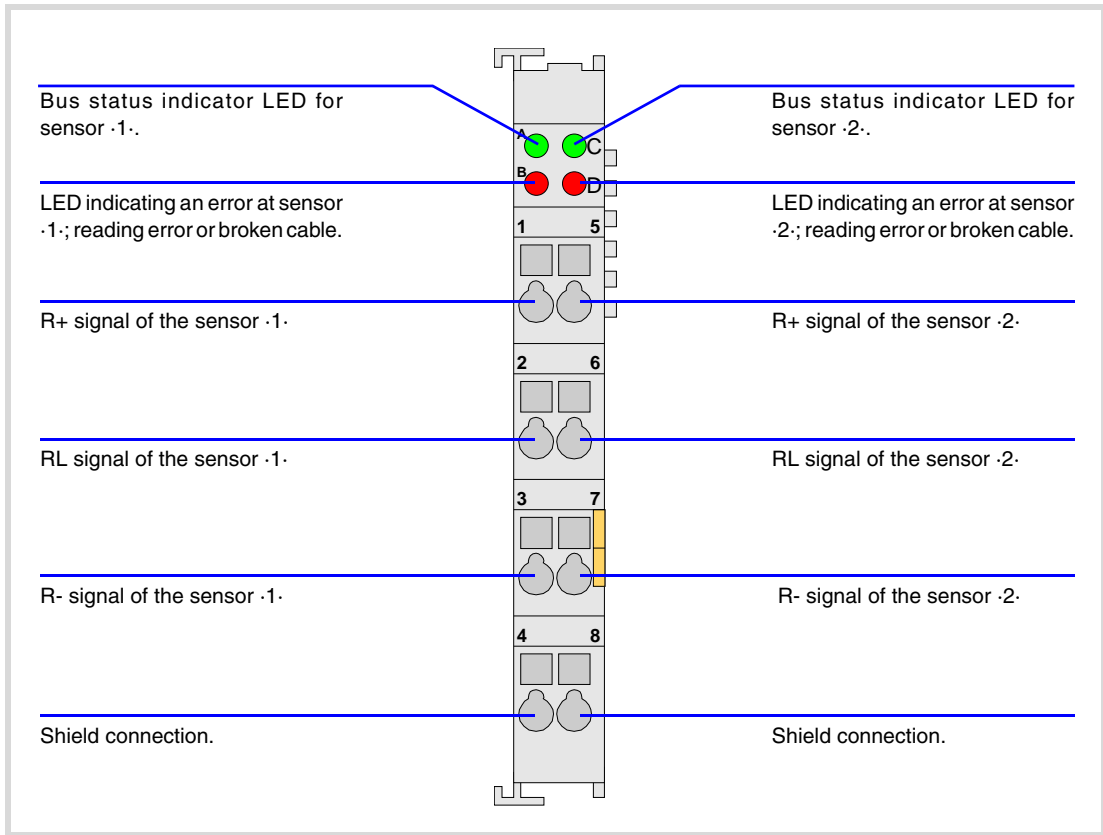

CNC 8070

(REF: 1007)

12.12.1 Elements (connectors).

Analog inputs for PT100 temperature sensors (2 inputs).

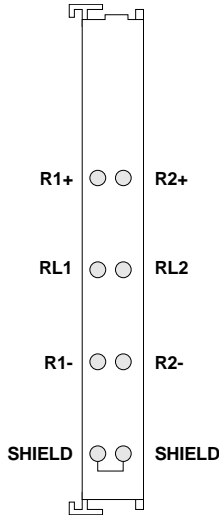

Signal	Function
R1+ RL1 R1-	Signals of the PT100 sensor.
R2+ RL2 R2-	Signals of the PT100 sensor.
SHIELD	Grid.

The shield connectors are internally joined together and are connected to the profile where the module is mounted

The module allows connecting sensors with a 2-wire or 3-wire interface.

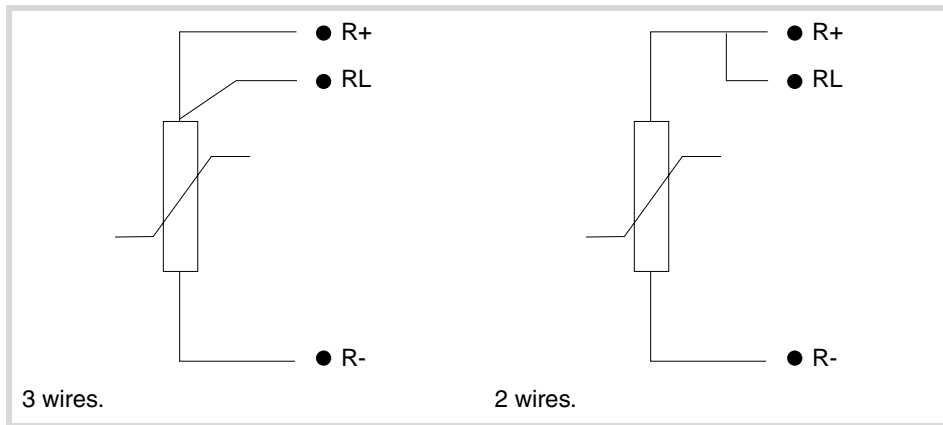

Led ·BUS·. Data bus status.

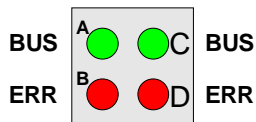

Green LED's. Both inputs have an LED that turns on when transmission at the bus is OK.

Led ·ERR·. Error at the outputs.

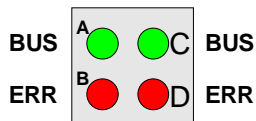

Red LED's. Both inputs have an LED that turns on when there is an input reading error; reading out of range or broken cable.

12.

RIOW REMOTE MODULES. (CANOPEN PROTOCOL).

12.13 RIOW-END module. Last module of the group.

The RIOW-END module must be present in all the groups and must be the last module of the group. This module is used to end the internal bus of the group and ensure proper data flow.

12.

RIOW REMOTE MODULES. (CANOPEN PROTOCOL).

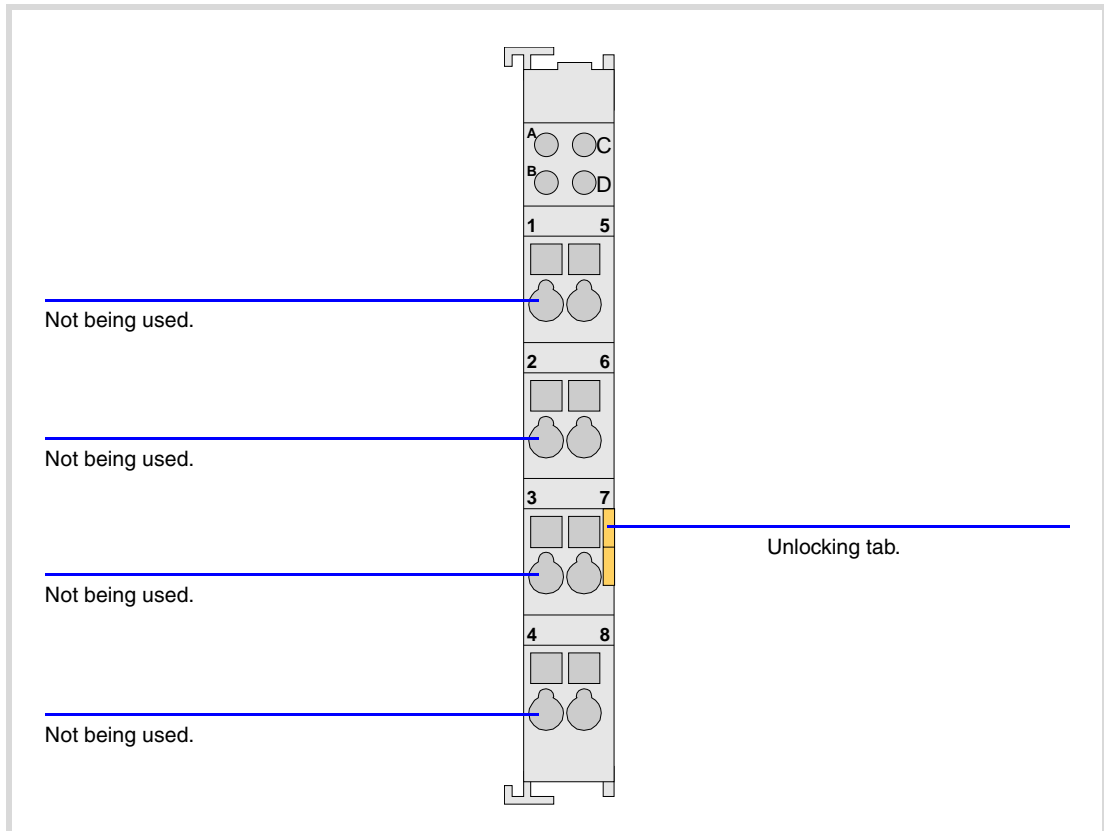

12.14 Numbering of the digital inputs and outputs.

Use machine parameters to set the number of digital I/O modules connected to the CAN bus. If these parameters are not defined, the CNC numbers the modules automatically according to the logic order of the remote groups.

Numbering according to the order of the remote groups.

The CNC numbers the modules automatically according to the logic order of the remote groups. Within each group, they are ordered from left to right.

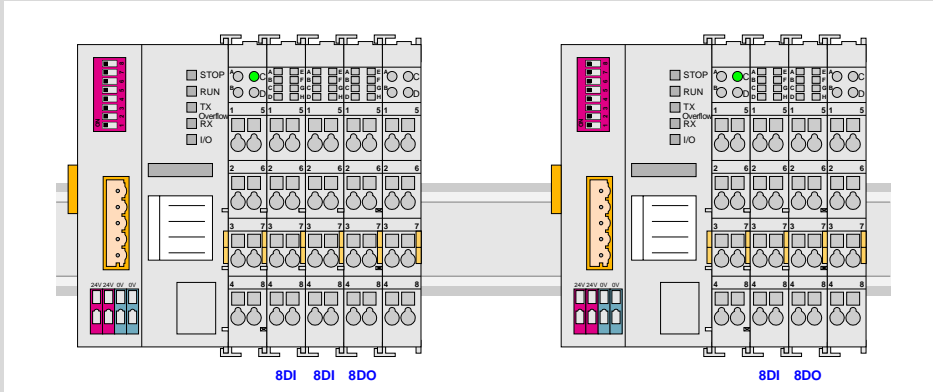

Group -1-	Group -2-
8 + 8 digital inputs.	8 digital inputs.
8 digital outputs.	8 digital outputs.

Example 1.

	Group -1- (address = 1)	Group -2- (address = 2)
Digital inputs.	1 .. 8 9 .. 16	17 .. 24
Digital outputs.	1 .. 8	9 .. 16

Example 2.

	Group -1- (address = 2)	Group -2- (address = 1)
Digital inputs.	9 .. 16 17 .. 24	1 .. 8
Digital outputs.	9 .. 16	1 .. 8

Numbering by machine parameters.

When the numbering is set by machine parameters, each module is assigned a base index and the inputs or outputs of that module are numbered after it.

The values of the base index must be comply with the formula "8n + 1" (i.e. 1, 9, 17, 25, etc.). The rest of the inputs or outputs are numbered sequentially. The base indexes may follow any order, they do not have to be sequential.

When inserting a new module, the first modules will be assigned the numbering of the table and the last one will be assigned the next valid base index after the highest one assigned until then.

12.

RIOW REMOTE MODULES. (CANOPEN PROTOCOL).

Examples for numbering the different modules.

GROUP = 1

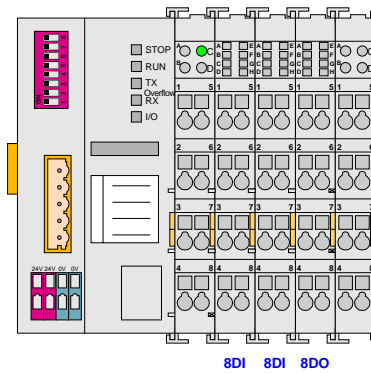

GROUP = 2

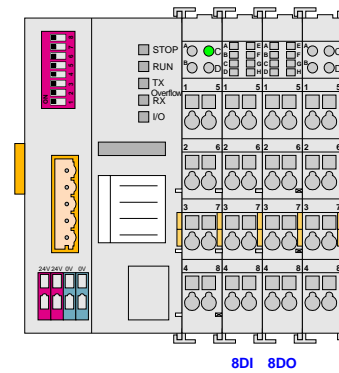

Remote group (1).

	Digital inputs		Digital inputs	
	Base index	Numbering	Base index	Numbering
module 1	1	1 .. 8	81	81 .. 88
module 2	33	33 .. 40		

Remote group (2).

	Digital inputs		Digital inputs	
	Base index	Numbering	Base index	Numbering
module 1	113	113 .. 120	49	49 .. 56

12.15 Numbering of the analog inputs and outputs and of the temperature sensor inputs.

The CNC numbers the modules automatically according to the logic order of the remote groups. Within each group, they are ordered from left to right.

When numbering the analog inputs, the CNC considers the inputs for the temperature sensor as analog inputs. The CNC machine parameters must be set to indicate the number of PT100 inputs and to which analog inputs they are connected. A PT100 input is active if it has one of these temperature sensors connected to it. Refer to the installation manual for further detail.

GROUP = 1

4AI 2AI 4AI 4AO
PT100

GROUP = 2

2AI 4AO
PT100

Group -1-	Group -2-
4 + 4 analog inputs.	4 analog inputs.
4 analog inputs.	2 PT100 inputs.
2 PT100 inputs.	

Example.

	Group -1- (address = 1)	Group -2- (address = 2)
Analog inputs.	1 .. 4	11 .. 12
PT100 inputs.	5 .. 6	
Analog inputs.	7 .. 10	
Analog outputs.	1 .. 4	5 .. 8

12.

RIOW REMOTE MODULES. (CANOPEN PROTOCOL).



CNC 8070

(REF: 1007)

13 EMERGENCY BATTERY.

The emergency battery ensures the operation of the central unit against power failures and, if necessary, allows the CNC to execute the automatic shut-down sequence due to a power failure.

13.

EMERGENCY BATTERY.

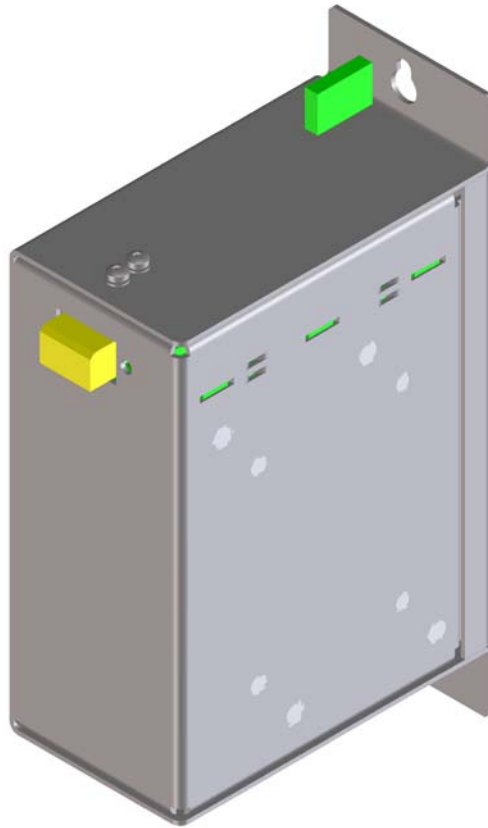

General characteristics.	
Charge time.	35 hours.
Autonomy.	About 20 minutes with the battery completely charged.
Work temperature.	Between 5 °C (41 °F) and 40 °C (104 °F).



Read the connection instructions carefully before connecting the battery. Connect the battery only to the central unit; DO NOT try to power any other device with the battery. Recharge the battery only through the central unit; DO NOT try to recharge it with any other device. Do not through the battery into the fire. Do not short-circuit the pins of the battery.

13.1 Battery dimensions.

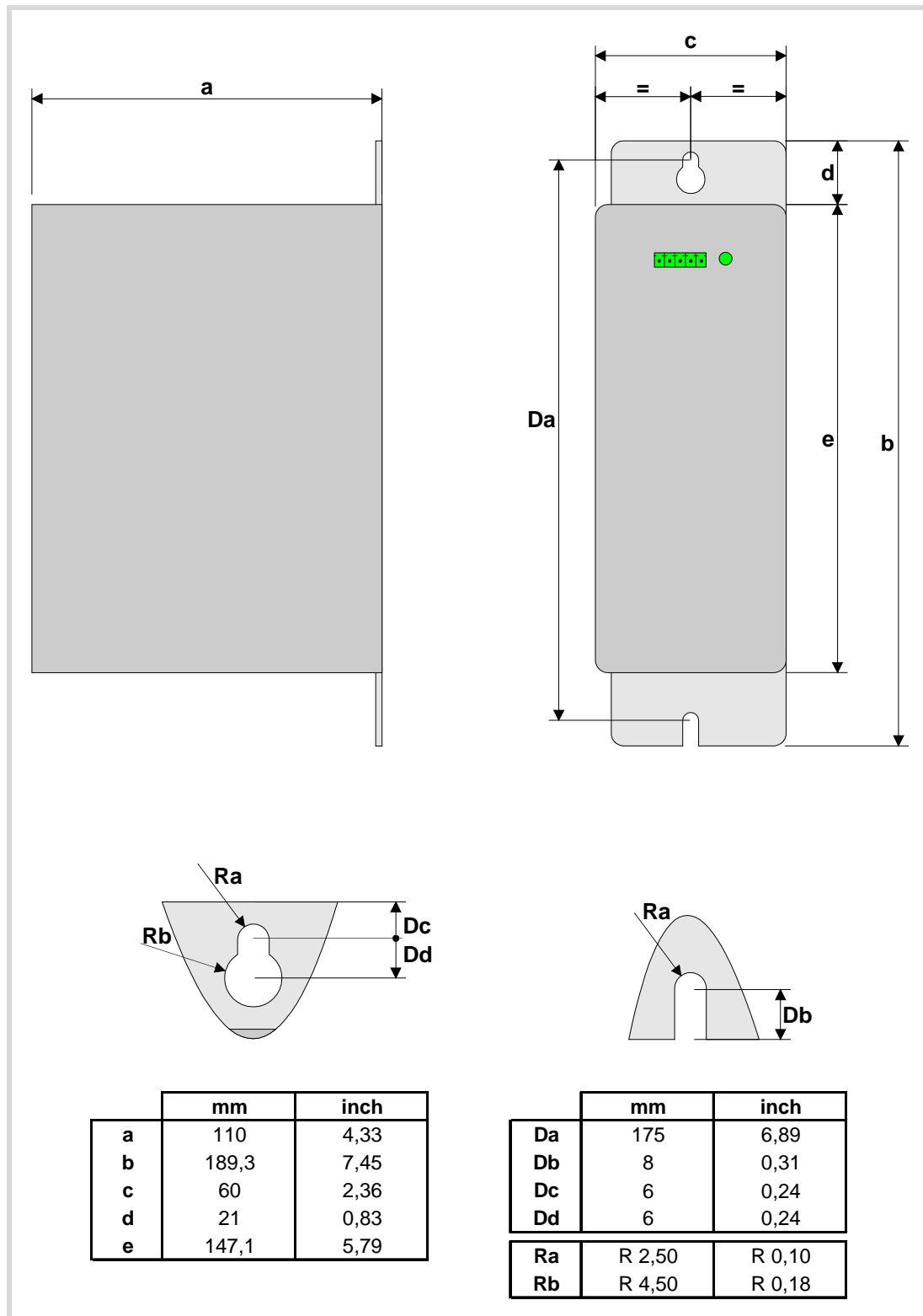

13.

EMERGENCY BATTERY.



CNC 8070

(REF: 1007)

13.2 Connectors and connection.

Connector. Powering the central unit and charging the battery.

5-pin male Phoenix minicombicon contact (3.5 mm pitch).

Signal	Function
Vbat - Vbat +	Central unit powered by the battery.
Chassis	Shield.
Vch - Vch +	Recharging the battery through the central unit.

The battery has a single connector to charge it and to power the CNC when necessary.

Status indicator LED.

The LED located next to the connector indicates the status of the battery. The LED blinks while the battery is being charged and it stays on when the battery is charged.

Connection to the central unit (ICU and MCU).

Connect all the pins of the battery to the central unit. The battery is charged from the central unit; DO NOT use any other device to recharge it.

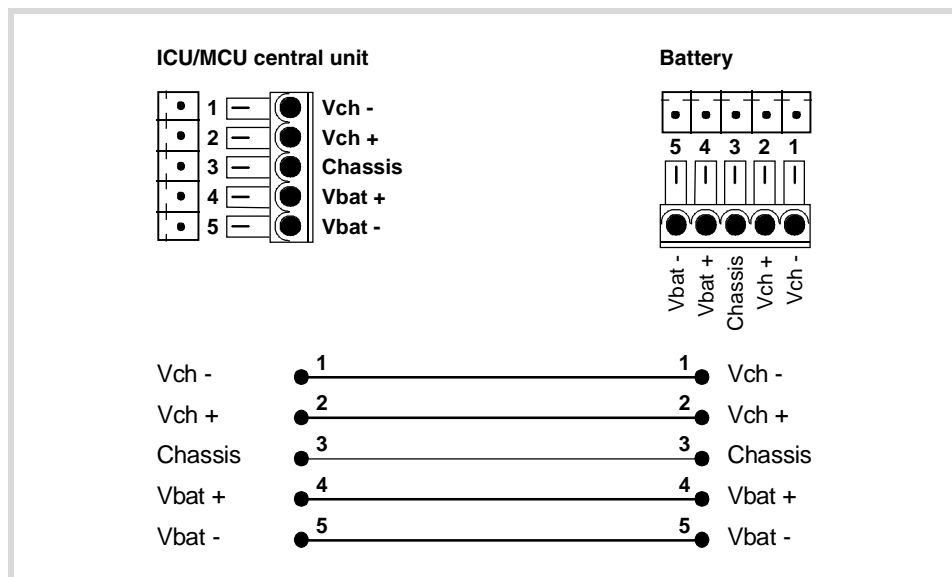

13.

EMERGENCY BATTERY.

13.3 Operation of the emergency battery.

Central unit powered by the battery.

The battery only powers the central unit when a failure occurs at the power supply (a drop of the 24 V). The Fagor battery provides an autonomy of about 20 minutes when it is fully charged.

Response of the CNC with battery to mains failures.

When a power supply failure occurs (drop at the 24 V) and there is a battery connected to the central unit, the latter responds as follows:

- If the supply is interrupted for less than 2 seconds.
The CNC shows the corresponding warning and the system recovers fine. Errors may occur at the CAN bus due to the lack of 24 V at the remote modules.
- If the supply is interrupted for more than 2 seconds.

After the 2 seconds, the CNC shows the corresponding error and it initiates the automatic shut-down sequence. First of all, the CNC stops any process in progress (program in execution, tool change, etc.) and closes the CNC8070 application. Then, the CCN shuts the whole system down and, finally, deactivates the battery.

Recharging the battery.

The battery is charged from the central unit; DO NOT use any other device to recharge it. The LED next to the connector blinks while the battery is being charged and it stays on when the battery is charged. The charging process takes about 35 hours.

13.

EMERGENCY BATTERY.

14 BUS CAN (CANFAGOR/CANOPEN PROTOCOLS).

CANfagor and CANopen are two network communication protocols based on the CAN bus system for connecting the CNC with remote modules and keyboards. The CAN connection supports up to 32 devices (nodes), including the central unit; more one than keyboard and several groups of remote modules are possible.

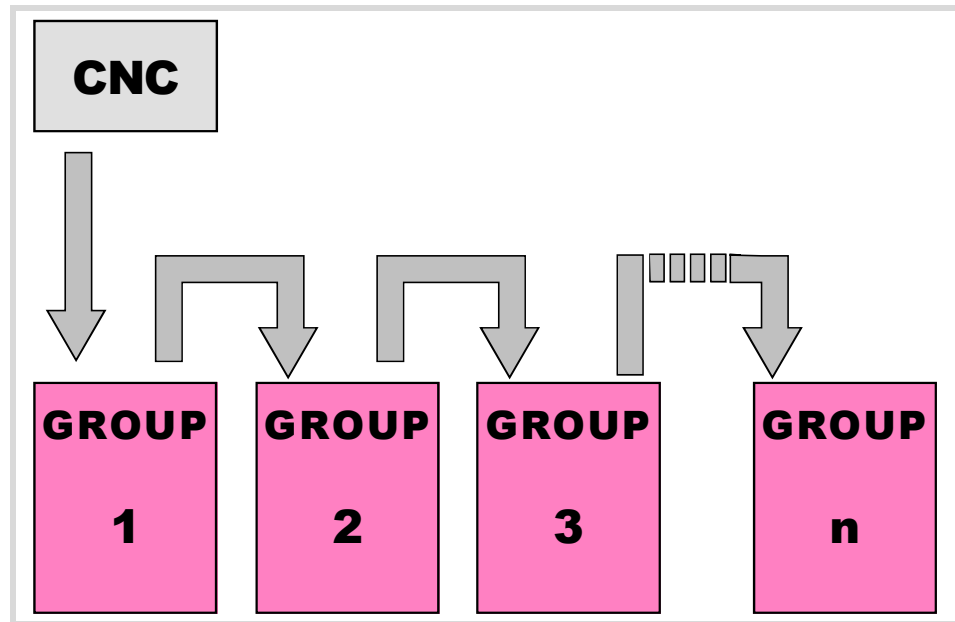

CAN connector.

5-pin male Phoenix minicombicon contact (3.5 mm pitch).

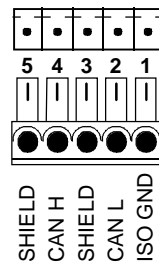

Pin.	Signal.	Function.
1	ISO GND	Ground / 0 V.
2	CAN L	(LOW) bus signal.
3	SHIELD	CAN shield.
4	CAN H	(HIGH) bus signal.
5	SHIELD	CAN shield.

The cable shield must be connected to the connector at both ends. The connector has two shield pins. Both pins are equivalent and the CAN shield may be connected to either one.

CAN cable characteristics.

Use a specific CAN cable. The ends of all the wires and the shield must be protected by the corresponding terminal (pin). Also use the terminals (pins) to secure the cable to the connector.

General characteristics.	
Type.	Shielded. Twisted pair (1 x 2 x 0.22 mm ²).
Flexibility.	Extremely flexible. Minimum bending radius, static = 50 mm and dynamic = 95 mm.
Cover.	PUR
Impedance.	Cat.5 (100Ω - 120Ω)

14.

BUS CAN (CANFAGOR/CANOPEN PROTOCOLS).



CNC 8070

(REF: 1007)

Module interconnection.

Respect the cable's minimum bending radius when connecting it. They must be connected in series; on elements having two CAN connectors, either one may be used. Once the elements have been connected, define their logic order in the bus and the transmission speed.

RIO5 y RIO70 series remote modules.

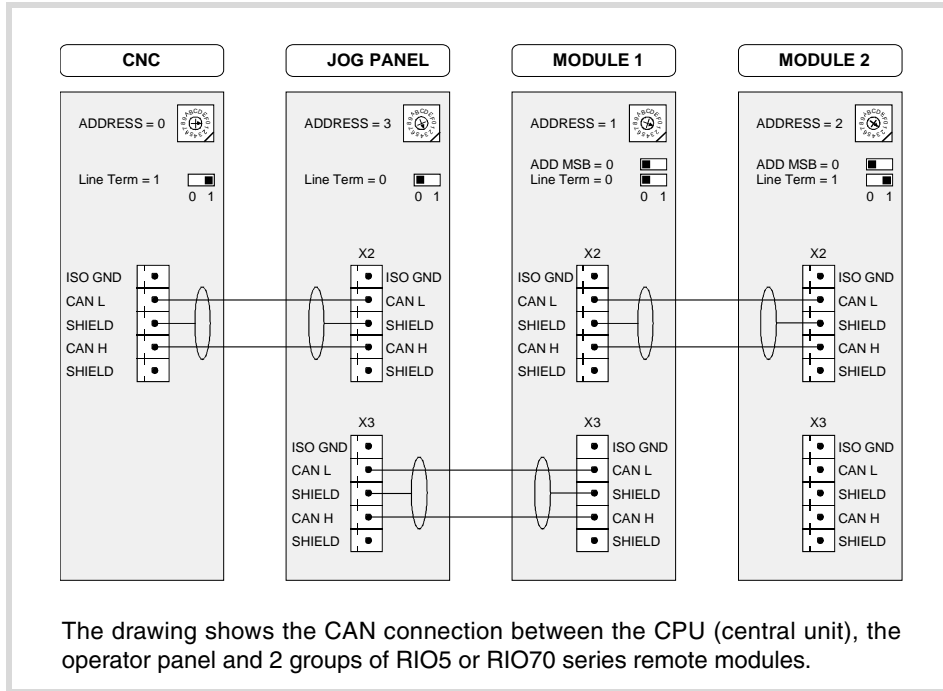

RIOW series remote modules.

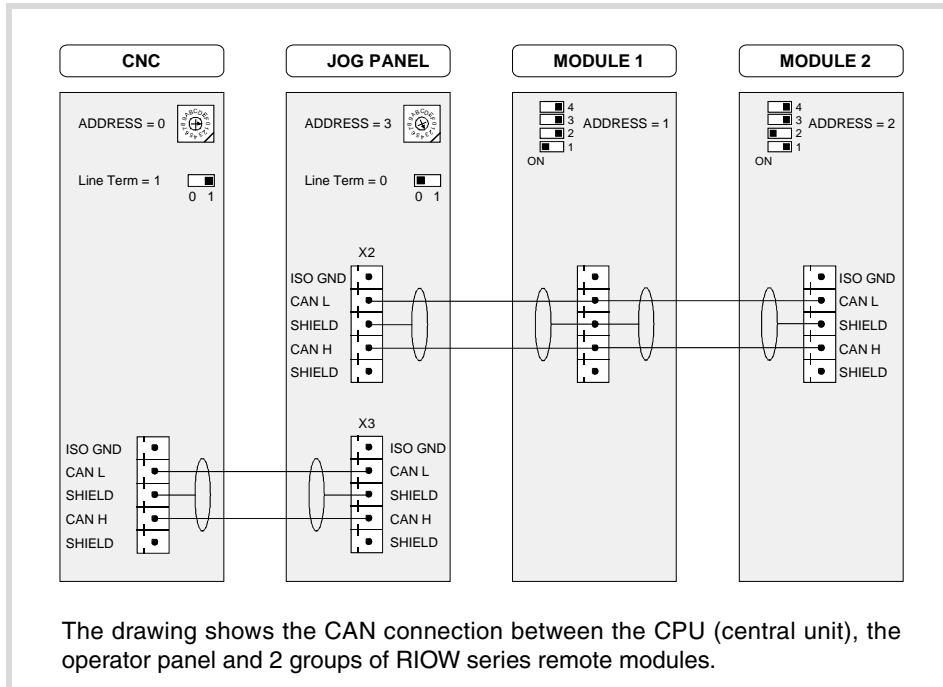

14.1 Identification of the modules at the bus.

Each one of the elements integrated into the CAN bus is identified by its address or node number. The CNC must always occupy position "0" and the rest of the elements of the bus will occupy consecutive positions starting with 1.

The node address or number also sets the priority of the group within the bus; the lower the number the higher the priority. We recommend to set the priority of the groups as follows (from highest to lowest).

- The groups that have the feedback inputs.
- The groups that have analog inputs and outputs.
- The groups that have digital inputs and outputs.
- The keyboard and jog panel.

Configuring the address (node number). Operator panel and RIO5 and RIO70 series remote modules.

.ADDRESS. selector. Address (node) of the element within the bus.



Each one of the elements integrated into the CAN bus is identified by the 16-position rotary switch (0-15) "Address" (also referred to as "Node_Select"). With the ADD MSB" switch, the positions or elements integrated in the CAN bus may be expanded up to 32.

In order for any change at the "Address" switch to be assumed, the CNC must be restarted and the corresponding drive must be reset, however, we recommend to change the address while the modules and the CNC are off.

The "Address" switch also sets the priority of the group within the bus; the lower the number the higher the priority. We recommend the keyboard and jog panel to be the last node of the bus.

.ADD MSB. selector Address (node) of the element within the bus.

With the .4- switch (ADD MSB), the positions or elements integrated in the CAN bus may be expanded up to 32. Positions 0-15 are selected with ADD MSB=0 and positions 16-31 with ADD MSB=1.

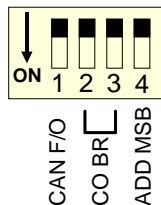

.CAN F/O.	Address (node) of the element.
OFF	Positions 0-15 within the bus.
ON	Positions 16-31 within the bus.

ADDRESS = 2

ADDRESS = 18

ADDRESS	0	1	2	3	...	13	14	15
ADD MSB =0	0	1	2	3	...	13	14	15
ADD MSB =1	16	17	18	19	...	29	30	31

14.

BUS CAN (CANFAGOR/CANOPEN PROTOCOLS).



CNC 8070

(REF: 1007)

Configuring the address (node number). RIOW series remote modules.

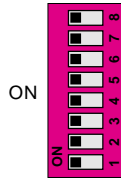

The dipswitch may be used to select the address of the node and the transmission speed.

The address (node number) of the group is selected while the module is off. Select the speed by putting the corresponding dipswitches in the *-on-* position. The binary meaning of each dipswitch increases according to its number; dipswitch *-1-* for address 1, dipswitch *-3-* for address 4 and so on.



Identification of the first and last elements of the bus. Line terminating resistor.

In the CAN bus, it is necessary to use a line terminating resistor to identify which are the elements that occupy the ends of the bus; i.e. the first and last physical element in the connection. For the central unit, the terminating resistor is factory installed because the CNC is always at one end of the bus.

Operator panel and RIO5 and RIO70 series remote modules. *-ST-* selector.



The *-LT-* switch identifies which are the elements that occupy the ends of the CAN bus; i.e. the first and last physical element in the connection.

The switch position of the terminating elements must be "1" and that of the rest of the elements "0". The central unit must always be at one end of the line even when not having this switch. The other end of the line will be the last physical device of the bus.

RIOW series remote modules.

The RIOW series modules do not have a factory-installed line terminating resistor. The RIOW module mounted at the end of the bus must have a 120 Ω line terminating resistor between pins CAN_H and CAN_L to avoid signal deflections (rebounds).

14.2 Type of CAN bus and baudrate.

Bus type selector: CANfagor / CANopen.

The CNC has two types CAN bus: CANfagor and CANopen. There are specific remote modules for each type of bus; at the CNC and at the operator panels, the type of active CAN bus must be selected.

Bus type selection at the operator panels.

Switch ·1· (CAN F/O) selects the type of CAN bus to be used, i.e. CANfagor or CANopen.

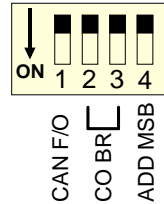

·CAN F/O·	Type of CAN bus.
OFF	The CANfagor bus has been selected.
ON	The CANopen bus has been selected.

Bus type selection at the CNC.

At the CNC, the type of CAN bus is selected by means of the machine parameters (parameter CANMODE),

14.

BUS CAN (CANFAGOR/CANOPEN PROTOCOLS).

14.3 Selecting the baudrate for the CANopen bus.

When using the CANopen protocol, the transmission speed at the bus is defined in each node and they all must run at the same speed. The transmission speed depends on the total length of the bus. Using the following illustrative values; assigning other values may cause communication errors due to signal distortion.

Speed	Length of the CAN bus.
1000 kHz	Up to 20 meters.
800 kHz	From 20 to 40 meters.
500 kHz	From 40 to 100 meters.
250 kHz	From 100 to 500 meters. The speed of 250 kHz is only available to communicate with the keyboards and RIO5 series remote modules; this speed is not available at the RIO5 series remote modules.

14.

BUS CAN (CANFAGOR/CANOPEN PROTOCOLS).

Selecting the speed at the CNC.

The CNC detects the transmission speed (baudrate) automatically by asking the rest of the nodes connected to it.

Speed selection at the operator panels.

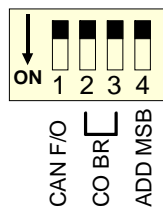

The speed is selected with switches -2- and -3- (CO BR).

In order for any change of speed to be assumed, the corresponding module must be reset; however, we recommend to change the speed while the modules and the CNC are off.

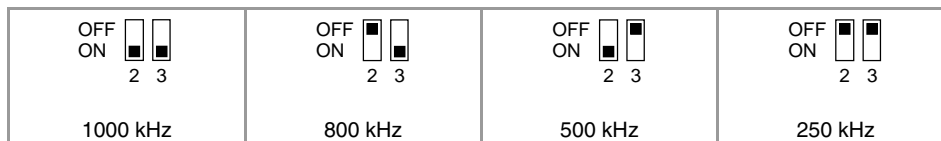

Speed selection at RIO5 remote modules.



The speed is selected with the -SPEED- switches.

In order for any change of speed to be assumed, the corresponding module must be reset; however, we recommend to change the speed while the modules and the CNC are off.

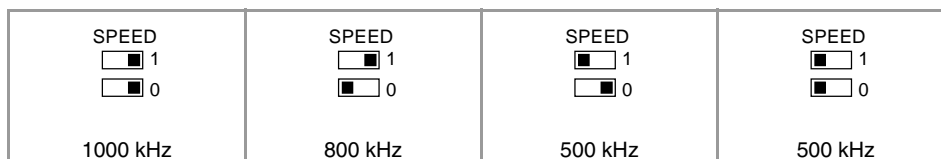

The communication at 250 kHz is not available at the RIO5 series remote modules.

Speed selection at RIO5 remote modules.



The dipswitch may be used to select the address of the node and the transmission speed.



The dip-switch of the previous figure corresponds to the RIO5-CANOPEN-ECO module. The dip-switch of the RIO5-CANOPEN-ECO and RIO5-CANOPEN-STAND modules is the same but rotated 180°, so the -ON- position is inverted between them.

To select the speed of the node, the module must be in configuration mode (all the dipswitches in the -off- position). After turning the module on in configuration mode, the top 4 LED's of the module blink indicating the speed selected at the module. The STOP LED



CNC 8070

(REF: 1007)

corresponds to dipswitch ·1·, the RUN to dipswitch ·2·, the TX to dipswitch ·3· and the RX to dipswitch ·4·. The first time the module is configured, the TX LED blinks indicating that no valid speed has been selected.



If when turning the module on, all the dipswitches are not in the ·off· position, the position of the dipswitches will be the new address (node number) of the group.

The first 4 dipswitches are used to select the speed; the rest must be in the ·off· position. To select the speed, put the corresponding dipswitches in the ·on· position.

Dipswitch ·1·	Dipswitch ·2·	Dipswitch ·3·	Dipswitch ·4·	Speed
Off	Off	Off	Off	1000 kHz
ON	Off	Off	Off	800 kHz
Off	ON	Off	Off	500 kHz
ON	ON	Off	Off	250 kHz

To save the selected speed, put dipswitch ·8· in the ·on· position. After saving the configuration, the corresponding LED's turn on to indicate the module speed. For 1 MHz, all four LED's turn on.

Once the speed has been selected, turn the module off by removing power and set dip-switch ·8· in the ·off· position. Bear in mind that the next time the module is turned on, the position of the dipswitches will indicate the address (node number) of the group.

14.

BUS CAN (CANFAGOR/CANOPEN PROTOCOLS).



CNC 8070

(REF: 1007)

14.4 Selecting the speed for the CANfagor bus.

When using the CANfagor protocol, the transmission speed at the bus is defined at the CNC (parameter CANLENGTH). The transmission speed depends on the total length of the cable. Use the following approximate values. Assigning other values may cause communication errors due to signal distortion.

Length (m)	Speed (KHz)	Length (m)	Speed (KHz)
20	1000	90	533
30	888	100	500
40	800	110	480
50	727	120	430
60	666	130	400
70	615	> 130	250
80	571		

14.

BUS CAN (CANFAGOR/CANOPEN PROTOCOLS).

15 SERCOS BUS.

15.

SERCOS BUS.

The Sercos interface is a communications standard especially designed for the machine-tool industry offering a simple interface between the CNC and the drives. All the data and commands are transmitted in digital format through fiber optic lines that make up a ring (the Sercos ring) that connects all the elements of the bus (CNC and drives) to each other. Using the Sercos interface considerably minimizes the necessary hardware, makes cabling simpler and grants greater reliability to the system making it immune to electrical interference (noise).

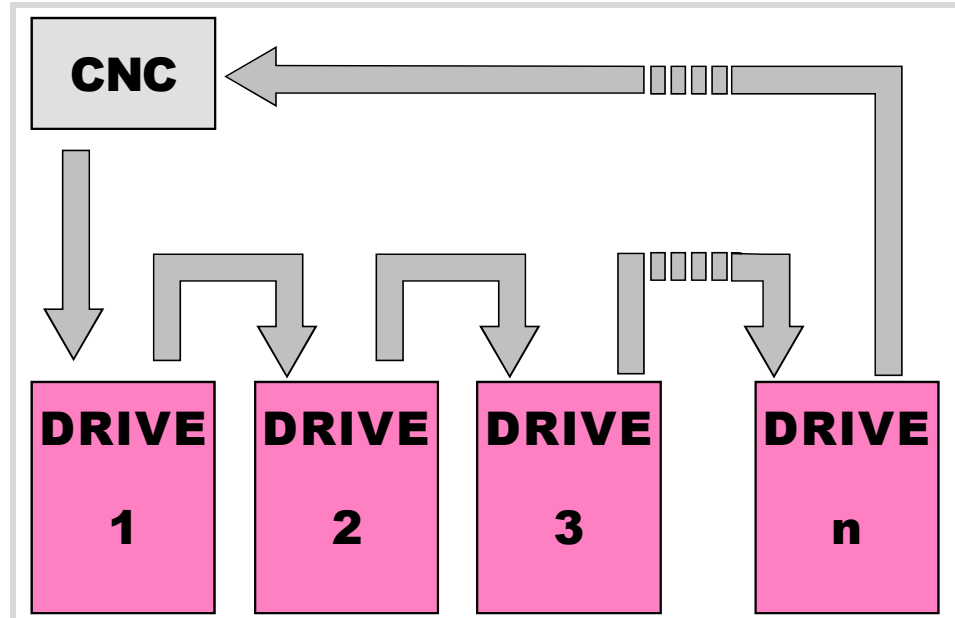

Sercos cable characteristics.

Fagor Automation supplies the fiber optic cables needed for Sercos communication. There are several types of cable depending on their length and their dynamic and static installation characteristics.

- Fiber optic cable with polymer core (SFO, SFO-FLEX) for up to 40 meters. If the fiber optic cable is going to withstand dynamic conditions (moving), always use the SFO-FLEX cable. If the fiber optic cable is going to withstand static conditions (not moving), always use the SFO cable.
- Fiber optic cable with glass core (SFO-V-FLEX) for over 40 meters.

Mechanical cable characteristics.

SFO cable.	
Flexibility.	Normal. Minimum bending radius of 30 mm. Only to be used in static systems (not moving).
Cover.	PUR. Polyurethane resistant to chemicals used in machines.
Temperature.	Working: -20 °C / 80 °C (-4 °F / 176 °F). Storage: -35 °C / 85 °C (-31 °F / 158 °F).

SFO-FLEX cable.	
Flexibility.	High. Minimum bending radius, static = 50 mm and dynamic = 70 mm. Special cable to be used in cable chains.
Cover.	PUR. Polyurethane resistant to chemicals used in machines.
Temperature.	Working: -20 °C / 70 °C (-4 °F / 158 °F). Storage: -40 °C / 80 °C (-40 °F / 176 °F).



CNC 8070

(REF: 1007)

SFO-V-FLEX cable.	
Flexibility.	Minimum bending radius, static = 45 mm and dynamic = 60 mm.
Cover.	PUR. Polyurethane resistant to chemicals used in machines.
Temperature.	Working: -40 °C / 80 °C (-40 °F / 176 °F). Storage: -40 °C / 80 °C (-40 °F / 176 °F).

Cable handling.

The cable provided by Fagor has its pins protected with a hood. Before connecting the cable, remove the protecting hood.

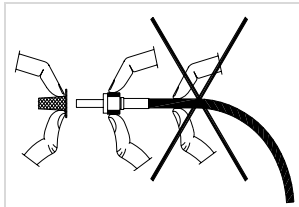

Both for removing the pins protecting hood for the pins and for plugging and unplugging the cable, hold the cable by its pin, never pull at the cable while holding it by its plastic part because it could make it useless.

15.

SERCOS BUS.

FAGOR 

CNC 8070

(REF: 1007)

15.1 Module identification and connection

15.

SERCOS BUS.

Module identification.

The CNC (except the ICU and MCU models) and the drives are identified with the 16-bit rotary switch "Address" (also called "Node_Select"). This switch selects the address (node) occupied by each of the elements integrated into the Sercos connection. Some CNC's (like the ICU and MCU models) do not have the switch; they are pre-configured to always occupy position ·0· at the bus.

The CNC must always occupy position 0 and the drives will occupy consecutive positions starting with 1. In order for any change at the "Address" switch to be assumed, the corresponding drive must be reset and the CNC powered off and back on.

Whether the drive identified with number 1 (for example) corresponds to the X axis, to the Y axis or to another one is irrelevant. However, it is a good idea, for clarity sake, that the machine axes X, Y, Z, U, V, W, A, B and C be assigned consecutive numbers in that order.



Then set certain CNC machine parameters to configure the connection.

Module interconnection.

The Sercos connection is carried out in a ring using fiber optic cable by joining an OUT terminal with an IN terminal. The drawing shows the Sercos connection of the CNC with Fagor spindle drives and the X, Y axes.

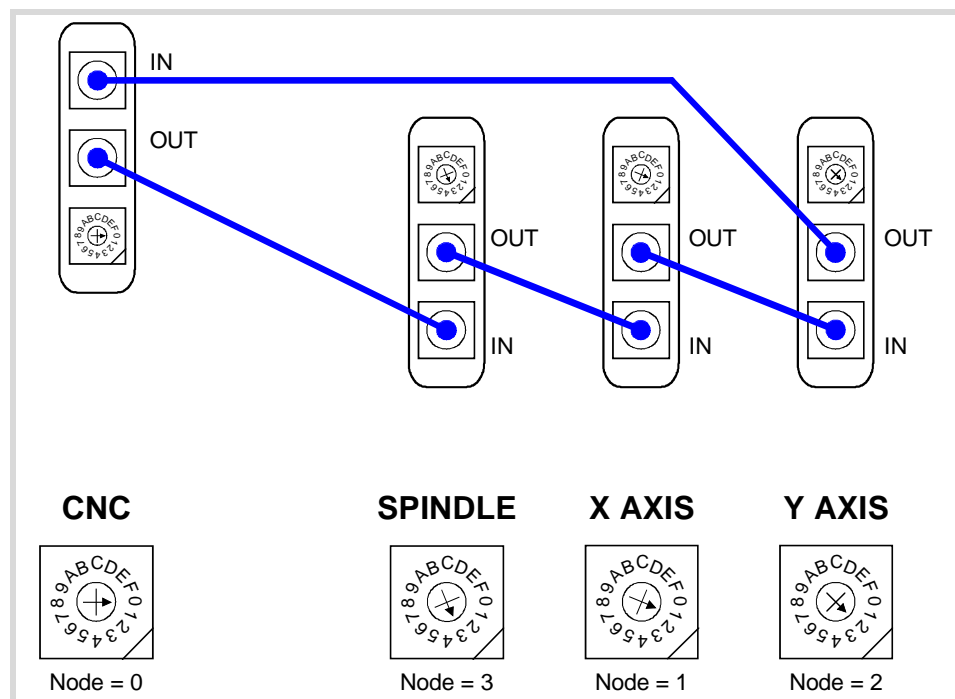

15.2 Data exchange via Sercos.

The data exchange between the CNC and the drives takes place in each position loop. The more data is exchanged, the more overloaded the Sercos transmission will be. These registers should be limited leaving only the ones absolutely necessary after the setup.

There is data that must necessarily be transmitted in every position loop (velocity commands, feedback, etc.) and other data that may be transmitted in several loops (monitoring, etc.). Since the CNC must know the priority of those transmissions, there must be two separate transmission channels.

Cyclic channel (fast).

The data is transmitted in every position loop. It contains velocity commands, feedback, etc. Each variable that is read or written at the drive is included in this data pack. In order not to overload the interface, you must limit the number of drive variables involved to the minimum necessary.

Indicate the type of data to be transmitted. The data to be sent to the drives must be placed in certain particular registers of the PLC and the data to be read from the drives is received in other registers of the PLC.

Service channel (slow).

The data is transmitted in several position loops. It contains monitoring data, etc.

This channel can only be accessed through high-level blocks in the part-program or from the PLC channel.

15.

SERCOS BUS.

16 MECHATROLINK BUS.

The Mechatrolink bus may be used to communicate with servos (axis and spindle) and inverters (spindle) in Mlink-I (17 bytes) mode and Mlink-II (17 or 32 bytes) mode. With this type of bus, up to 14 slaves may be connected in Mlink-I mode and 30 slaves in Mlink-II mode (a repeater must be used to connect more than 16 slaves).

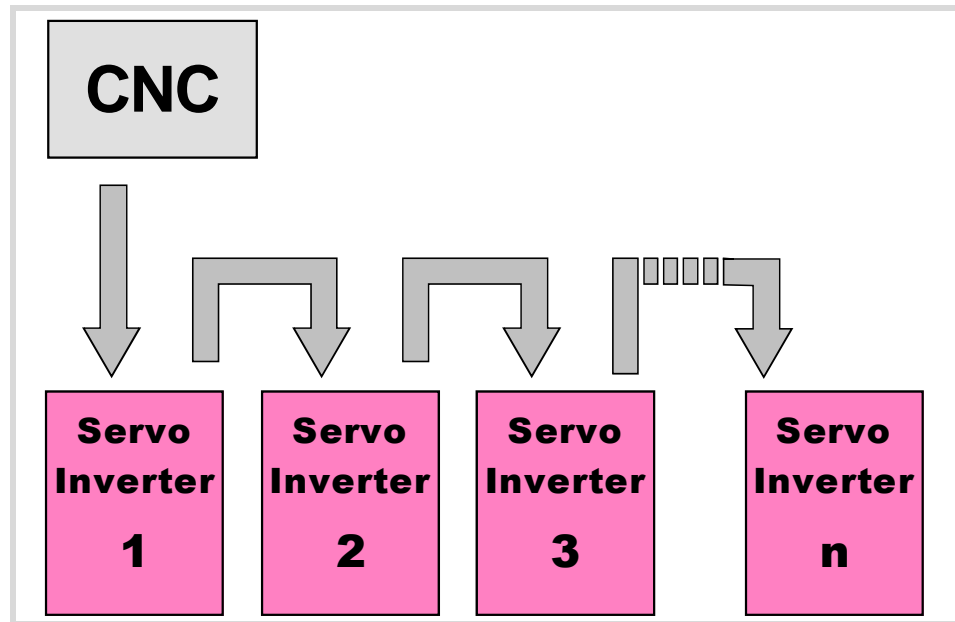

Mechatrolink cable characteristics.

Use a specific Mechatrolink cable. The maximum length of the cable is 50 m (164 ft). The minimum length of the cable between elements is 0.3 m (1 ft) in Mlink-I mode and 0.5 m (1.7 ft) in Mlink-II mode.

Item.	Description.
Type.	Shielded. Twisted pair.
Impedance.	130 Ω .

Twisted-pair shielded cable should be used to minimize interference between cables, thus preventing poor communication in long lengths.

Identification of the first and last elements of the bus. Line terminating resistor.

In the bus, it is necessary to use a line terminating resistor to identify which are the elements that occupy the ends of the bus; i.e. the first and last physical element in the connection. For the central unit, the terminating resistor is factory installed because the CNC is always at one end of the bus.

16.

MECHATROLINK BUS.



CNC 8070

(REF: 1007)

16.

MECHATROLINK BUS.



CNC 8070

(REF: 1007)

17 INSTALLING AND CONFIGURING A THIN CLIENT (EPATEC MODEL).

The Thin Client is recommended for configurations where the VGA cable cannot be used to connect the central unit with a second monitor (e.g. the passive screen LCD-15SVGA) due to too much distance. The central unit and the Thin Client will communicate via Ethernet (local network or point to point) and the Thin Client will be in charge of sending the VGA signal to the passive screen. Both monitors show the same video signal. A mouse connected to the Thin Client may also be used with to interact with the CNC.

The central unit and the Thin Client communicate through a remote desktop software, in this case VNC, where the CNC is the server and the Think Client is the client.

The passive screen permits having a second work station consisting of the screen itself and an operator panel OP-PANEL-H/E. Connect the operator panel to the CAN bus of the system and the softkeys of the screen to the operator panel.



The softkeys of the passive screen will only operative if they are connected to the operator panel OP-PANEL-H/E.

Point-to-point connection.

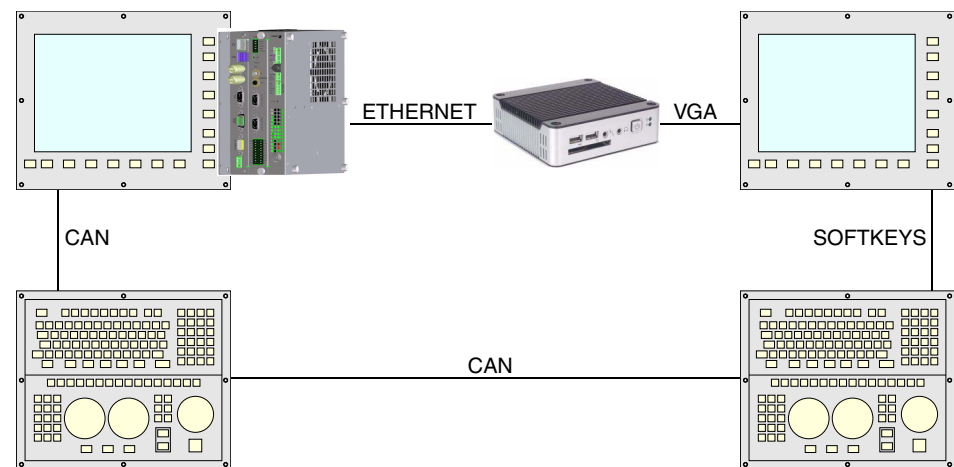

Connection within a local network (LAN).

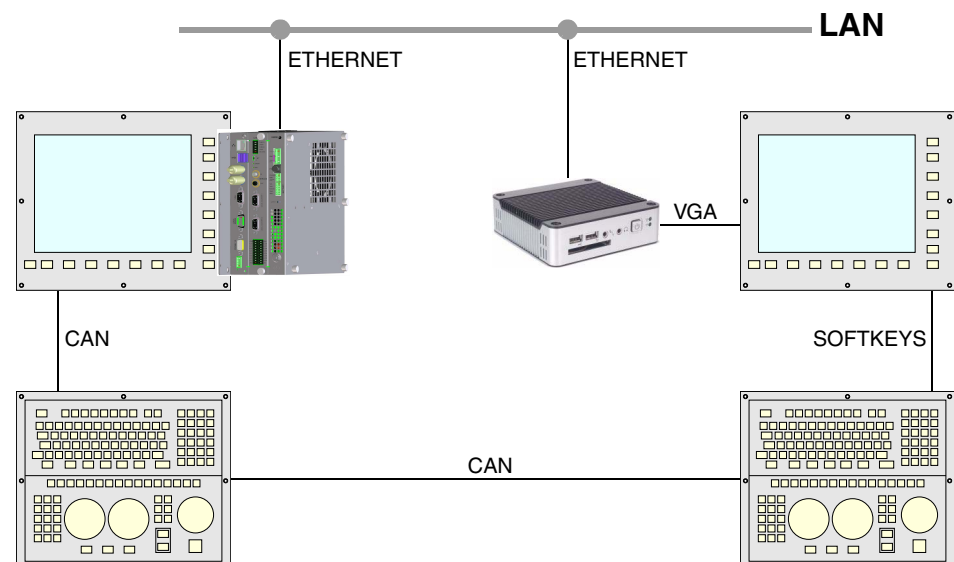

17.

INSTALLING AND CONFIGURING A THIN CLIENT (EPATEC MODEL).



CNC 8070

(REF: 1007)

Cable characteristics.

A cross cable must be used when connecting the Thin Client directly to the CNC (point-to-point connection). A standard 10BASE-T shielded cable must be used when connecting the Thin Client to a switch or within a local network. In either case, use a specific Ethernet cable.

Ethernet cable.	
Type.	Twisted pair. Shielded.
Impedance.	Cat.5 (100Ω - 120Ω) or greater.
Maximum length.	100 meters (328 ft).

In order to ensure proper performance, the connection cable must be inserted all the way into the connectors so they're latched. This ensures that the cable is properly latched and does not come off due to vibration.



17.1 Install and configure the communication software at the CNC.

The central unit and the Thin Client communicate through a third-party remote desktop software, in this case VNC. To install the VNC software, the CNC must be set in administrator mode. Refer to the installation manual for further detail.



The access to the administrator mode is enabled with the validation code ("Open system" software option). If you don't have this software option, (i.e. you have a "closed system") you will not be able to access the administrator mode and, therefore, you will not be able to install third-party software. If the CNC is not in administrator mode, the changes made to protected folders or files will be operative until the unit is turned off and back on, the CNC will then restore the initial configuration. The changes made to unprotected areas of the disk will remain.

During installation, follow the instructions appearing on the screen and, if necessary, select the following options.

- 1 Install only the "VNC Server" component.

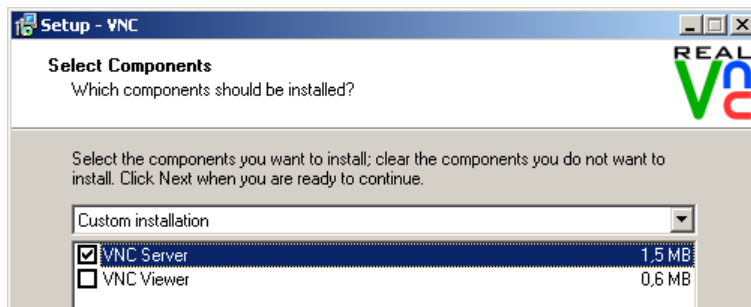

- 2 Select the following configuration options. With this configuration, start the CNC up, the VNC will remain waiting and its icon will appear in the notification area of the task bar (next to the clock).

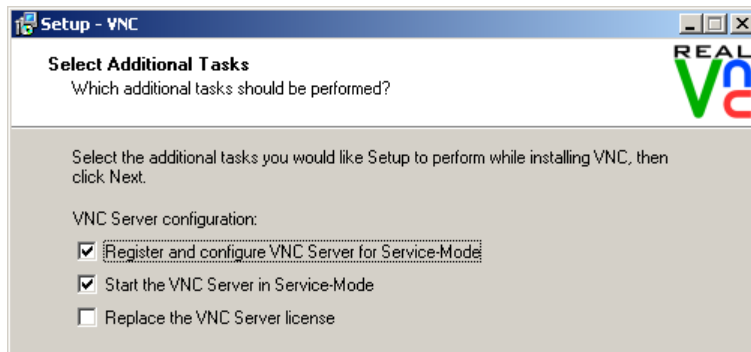

- 3 When installation is done, the program shows the following option tabs.

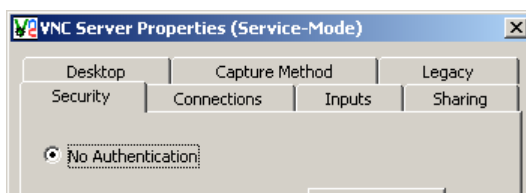

- on the "Security" tab, select "No Authentication".

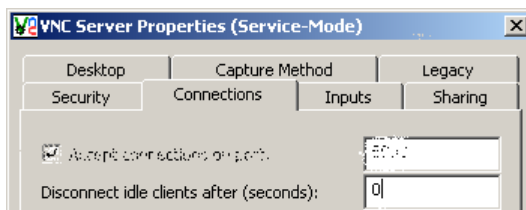

- On the "Connections" tab, select "Disconnect idle clients after (seconds)" with 0 seconds.

17.

INSTALLING AND CONFIGURING A THIN CLIENT (EPATEC MODEL).



CNC 8070

(REF: 1007)

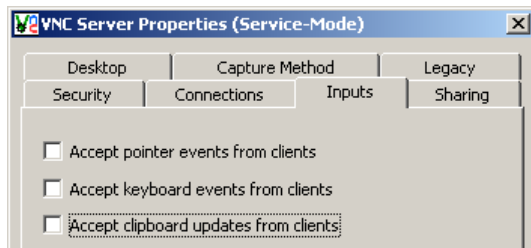

- On the "Inputs" tab, de-select the options "Accept keyboard events from clients" and "Accept clipboard updates from clients".
- The option "Accept pointer events from clients" is only taken into account when a mouse is connected to the Thin Client. When selecting this option, the Thin Client sends mouse events to the CNC.

17.

INSTALLING AND CONFIGURING A THIN CLIENT (EPATEC MODEL).



CNC 8070

(REF: 1007)

17.2 Configuring the Thin Client.

17.2.1 Configure the network protocol (for network or point-to point connection).



The software of the Thin Client has its own manual that is available on the manufacturer's website. In case of doubt, refer to the manufacturer's documentation.

The first time the Thin Client is turned on, a setup assistant comes up (language, IP address, etc.). When necessary, in the option "Do you want this terminal to be managed by a Scout NG manager?", select "No".

When the Thin Client startup is done, it shows several tabs that may also be used to configure the Thin Client. On the "Setup > Network" tab, select the "Manually" option and set the IP address (e.g. 10.0.0.102) and the network mask (e.g. 255.255.0.0). The network mask must be the same at the Thin Client and at the CNC.

The screenshot shows the eLux NG configuration window with the 'Setup' tab selected. Under the 'Network' sub-tab, the 'Manually' radio button is selected. The IP address is set to 10.0.0.102 and the Subnet is set to 255.255.0.0. The Hostname is eLux. There are also fields for Domain and DNS, and buttons for Add and Delete for each. At the bottom, there are Apply and Reset buttons.

Field	Value
IP address	10.0.0.102
Subnet	255.255.0.0
Gateway	
Hostname	eLux
Domain	
DNS	

17.

INSTALLING AND CONFIGURING A THIN CLIENT (EPATEC MODEL).

17.2.2 Configure the communication between the CNC and the Thin Client.

The Thin Client comes with a VNC client software. To configure the VNC start command, select the tab Configuration > New > Local and define the following data.

Name	VNC (or the desired name)
Application	Custom
Parameter	vncviewer10.0.7.250:0 -fullscreen (IP address of the CNC)
Start automatically	Select this option with a value of 5 s (illustrative value).
Application restart	Select this option so the Thin Client tries to re-establish communication without having to restart the system in case of communication loss for some time (because the Ethernet cable has been disconnected, for example).



The purpose of the "Start automatically" parameter is to start the VNC client of the Thin Client after the VNC of the CNC has been started up. The value of this parameter depends largely on how both devices, central unit and Thin Client, start up. If both elements start up at the same time or the Thin Client starts before the VNC server is available at the CNC, the VNC customer of the Thin Client cannot be connected and it will issue a connection error or data reading error. In this case, the time set for parameter "Start automatically" will have to be increased.

If the startup of the Thin Client depends on the CNC being started up first (e.g. condition the startup of the Thin Client to a PLC output), this "Start automatically" parameter could be set to 0 (zero).

Together with the command, it launches the IP address to which the Thin Client is connected. The address may be changed from Configuration > Edit > Local, in the Parameter window.

17.

INSTALLING AND CONFIGURING A THIN CLIENT (EPATEC MODEL).

FAGOR 

CNC 8070

(REF: 1007)

17.2.3 Configuring the startup of the Thin Client.

The BIOS must be modified in order for the Thin Client to start up automatically when powered on, without having to press the ON button. Having the Thin Client OFF, connect the external keyboard and, while starting up, press the [DEL] key to access the BIOS. The right side of the BIOS shows a menu with the instructions to browse through the BIOS.



The BIOS is an essential part in the operation of the Thin Client. Do not change any other parameter of the BIOS. The wrong manipulation of the BIOS parameters may render it useless.

- Once in the BIOS, select "Advanced > APM configuration" and access the options menu.

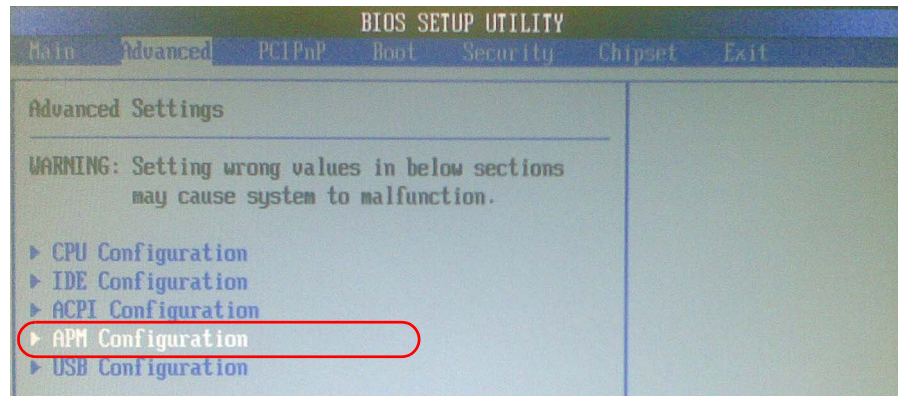

- Inside the menu "APM configuration", set the "Restore on AC/Power Loss" to [Power On].

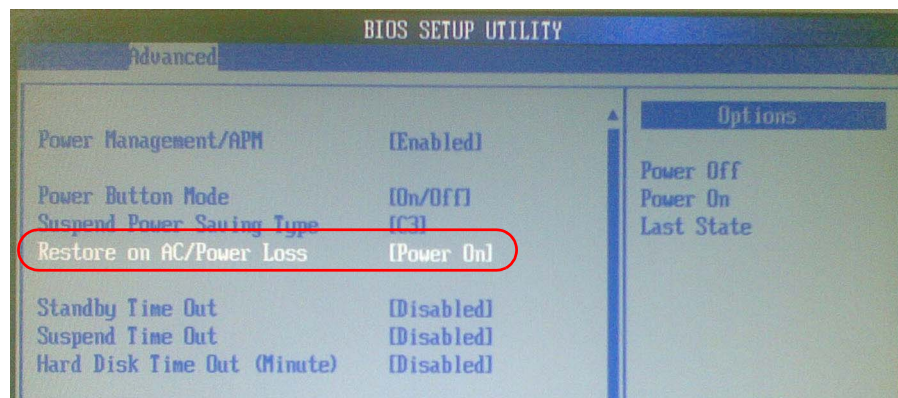

- Get out of the BIOS saving the changes.

17.

INSTALLING AND CONFIGURING A THIN CLIENT (EPATEC MODEL).

17.2.4 Disable the mouse at the Thin Client.

Once the setup of the Thin Client is done, the mouse must be disabled so the screen does not show the cursor.

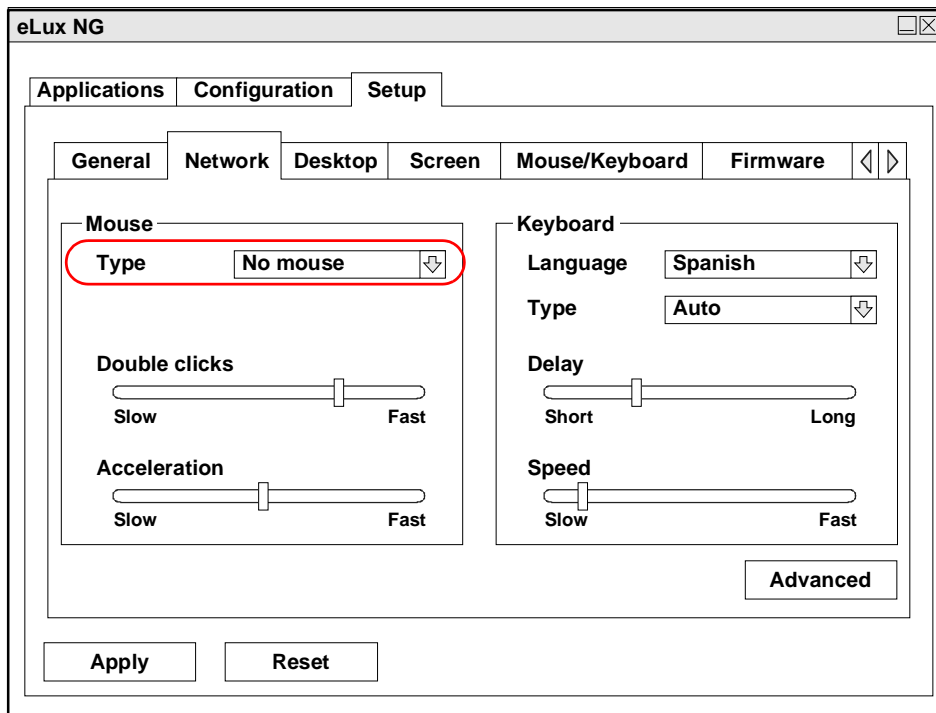
**17.**

INSTALLING AND CONFIGURING A THIN CLIENT (EPATEC MODEL).

17.

INSTALLING AND CONFIGURING A THIN CLIENT (EPATEC MODEL).



CNC 8070

(REF: 1007)